

**ROG  
CROSSHAIR  
X870E  
HERO**

**ASUS**

**Motherboard**

**Copyright © 2024 ASUSTeK COMPUTER INC. All Rights Reserved.**

No part of this manual, including the products and software described in it, may be reproduced, transmitted, transcribed, stored in a retrieval system, or translated into any language in any form or by any means, except documentation kept by the purchaser for backup purposes, without the express written permission of ASUSTeK COMPUTER INC. ("ASUS").

Product warranty or service will not be extended if: (1) the product is repaired, modified or altered, unless such repair, modification or alteration is authorized in writing by ASUS; or (2) the serial number of the product is defaced or missing.

ASUS PROVIDES THIS MANUAL "AS IS" WITHOUT WARRANTY OF ANY KIND, EITHER EXPRESS OR IMPLIED, INCLUDING BUT NOT LIMITED TO THE IMPLIED WARRANTIES OR CONDITIONS OF MERCHANTABILITY OR FITNESS FOR A PARTICULAR PURPOSE. IN NO EVENT SHALL ASUS, ITS DIRECTORS, OFFICERS, EMPLOYEES OR AGENTS BE LIABLE FOR ANY INDIRECT, SPECIAL, INCIDENTAL, OR CONSEQUENTIAL DAMAGES (INCLUDING DAMAGES FOR LOSS OF PROFITS, LOSS OF BUSINESS, LOSS OF USE OR DATA, INTERRUPTION OF BUSINESS AND THE LIKE), EVEN IF ASUS HAS BEEN ADVISED OF THE POSSIBILITY OF SUCH DAMAGES ARISING FROM ANY DEFECT OR ERROR IN THIS MANUAL OR PRODUCT.

SPECIFICATIONS AND INFORMATION CONTAINED IN THIS MANUAL ARE FURNISHED FOR INFORMATIONAL USE ONLY, AND ARE SUBJECT TO CHANGE AT ANY TIME WITHOUT NOTICE, AND SHOULD NOT BE CONSTRUED AS A COMMITMENT BY ASUS. ASUS ASSUMES NO RESPONSIBILITY OR LIABILITY FOR ANY ERRORS OR INACCURACIES THAT MAY APPEAR IN THIS MANUAL, INCLUDING THE PRODUCTS AND SOFTWARE DESCRIBED IN IT.

Products and corporate names appearing in this manual may or may not be registered trademarks or copyrights of their respective companies, and are used only for identification or explanation and to the owners' benefit, without intent to infringe.

# Contents

Safety information.....	4
About this guide.....	6
ROG CROSSHAIR X870E HERO specifications summary .....	8
Package contents.....	14
Connectors with shared bandwidth .....	15
<b>Chapter 1: Product Introduction</b>	
1.1 Before you proceed .....	17
1.2 Motherboard layout.....	18
1.3 Motherboard rear and audio connections .....	33
1.3.1 Rear I/O connection .....	33
1.3.2 LAN port LEDs .....	34
1.3.3 Audio I/O connections.....	34
<b>Chapter 2: Basic Setup</b>	
2.1 CPU installation.....	39
2.2 DIMM installation.....	42
2.3 M.2 module installation .....	43
2.4 Motherboard installation .....	51
2.5 ASUS WiFi Q-Antenna installation .....	52
2.6 BIOS FlashBack™.....	53
2.7 Starting up for the first time.....	54
2.8 Turning off the computer .....	54
<b>Chapter 3: BIOS and RAID Support</b>	
3.1 Knowing UEFI BIOS .....	55
3.2 ASUS EZ Flash 3 .....	56
3.3 ASUS CrashFree BIOS 3.....	57
3.4 RAID configurations .....	58
<b>Appendix</b>	
Q-Code table.....	59
General notices .....	63
Notices for Wi-Fi model .....	66
Warranty.....	74
ASUS contact information.....	77
Service and support.....	77
Product register.....	77

# Safety information

## Electrical safety

- To prevent electrical shock hazard, disconnect the power cable from the electrical outlet before relocating the system.
- When adding or removing devices to or from the system, ensure that the power cables for the devices are unplugged before the signal cables are connected. If possible, disconnect all power cables from the existing system before you add a device.
- Before connecting or removing signal cables from the motherboard, ensure that all power cables are unplugged.
- Seek professional assistance before using an adapter or extension cord. These devices could interrupt the grounding circuit.
- Ensure that your power supply is set to the correct voltage in your area. If you are not sure about the voltage of the electrical outlet you are using, contact your local power company.
- If the power supply is broken, do not try to fix it by yourself. Contact a qualified service technician or your retailer.

## Operation safety

- Before installing the motherboard and adding devices on it, carefully read all the manuals that came with the package.
- Before using the product, ensure all cables are correctly connected and the power cables are not damaged. If you detect any damage, contact your dealer immediately.
- To avoid short circuits, keep paper clips, screws, and staples away from connectors, slots, sockets and circuitry.
- Avoid dust, humidity, and temperature extremes. Do not place the product in any area where it may become wet.
- Place the product on a stable surface.
- If you encounter technical problems with the product, contact a qualified service technician or your retailer.
- Your motherboard should only be used in environments with ambient temperatures between 10°C and 35°C.

## Button/Coin Batteries Safety Information

1. Remove and immediately recycle or dispose of used batteries according to local regulations and keep out of reach of children. Do not incinerate or dispose of batteries in household trash.
2. If ingested or inserted inside any part of the body, call a local poison control center for treatment information. Even used batteries may cause serious injury or death.
3. This product uses CR2032 type batteries with a nominal voltage of 3V.
4. Do not attempt to recharge non-rechargeable batteries.
5. Do not forcibly discharge, recharge, disassemble, heat above the battery manufacturer's specified temperature rating, or incinerate. Doing so may result in injury or chemical burns caused by venting, leakage, or explosion.
6. This product contains non-replaceable batteries.

<b>⚠ WARNING</b>	
<ul style="list-style-type: none"><li>• <b>INGESTION HAZARD:</b> This product contains a button cell or coin battery.</li><li>• <b>DEATH</b> or serious injury can occur if ingested.</li><li>• A swallowed button cell or coin battery can cause <b>Internal Chemical Burns</b> in as little as <b>2 hours</b>.</li><li>• <b>KEEP</b> new and used batteries <b>OUT OF REACH OF CHILDREN</b>.</li><li>• <b>Seek immediate medical attention</b> if a battery is suspected to be swallowed or inserted inside any part of the body.</li></ul>	

## About this guide

This user guide contains the information you need when installing and configuring the motherboard.

## How this guide is organized

This guide contains the following parts:

- **Chapter 1: Product Introduction**  
This chapter describes the features of the motherboard and includes descriptions for each part of the motherboard.
- **Chapter 2: Basic Setup**  
This chapter lists the basic setup procedures for setting up your motherboard.
- **Chapter 3: BIOS and RAID Support**  
This chapter tells how to boot into the BIOS, upgrade BIOS using the EZ Flash Utility and support on RAID.

## Where to find more information

Refer to the following sources for additional information and for product and software updates.

1. **ASUS website**  
The ASUS website ([www.asus.com](http://www.asus.com)) provides updated information on ASUS hardware and software products.
2. **Optional documentation**  
Your product package may include optional documentation, such as warranty flyers, that may have been added by your dealer. These documents are not part of the standard package.
3. **Motherboard Installation Guide**  
Please visit <https://www.asus.com/support> for more information on the Motherboard Installation Guide.



**4. Driver and Utilities FAQ**

Please visit <https://www.asus.com/support> for more information on downloading and installing drivers and utilities for your motherboard.



**5. RAID Configuration Guide**

Please visit <https://www.asus.com/support> for more information on the RAID Configuration Guide.



**6. BIOS FlashBack™ Feature**

Please visit <https://www.asus.com/support> for more information on the BIOS FlashBack™ Feature.



## Conventions used in this guide

To ensure that you perform certain tasks properly, take note of the following symbols used throughout this user guide.

<b>CAUTION</b>	Information to prevent damage to the components and injuries to yourself when trying to complete a task.
<b>IMPORTANT</b>	Instructions that you <b>MUST</b> follow to complete a task.
<b>NOTE</b>	Tips and additional information to help you complete a task.

## ROG CROSSHAIR X870E HERO specifications summary

CPU	<p>AMD Socket AM5 for AMD Ryzen™ 9000 &amp; 8000 &amp; 7000 Series Desktop Processors*</p> <p>* Refer to <a href="https://www.asus.com/support/download-center/">https://www.asus.com/support/download-center/</a> for CPU support list.</p>
Chipset	AMD X870E
Memory	<p>4 x DIMM slots, max. 192GB, DDR5</p> <p>Supports up to 8200+MT/s(OC) with Ryzen™ 9000 Series Processors, 8600+MT/s(OC) with Ryzen™ 8000 Series Processors, 8000+MT/s(OC) with Ryzen™ 7000 Series Processors, ECC and Non-ECC, Un-buffered Memory*</p> <p>Dual channel memory architecture</p> <p>Supports AMD Extended Profiles for Overclocking (EXPO™)</p> <p>NitroPath DRAM Technology</p> <p>ASUS Enhanced Memory Profile (AEMP)</p> <p>* <b>Supported memory types, data rate (speed), and number of DRAM modules vary depending on the CPU and memory configuration, for more information please refer to CPU/Memory Support list under the Support tab of product information site or visit <a href="https://www.asus.com/support/download-center">https://www.asus.com/support/download-center</a>.</b></p> <p>* <b>Non-ECC, Un-buffered DDR5 Memory supports On-Die ECC function.</b></p>
Graphics	<p>1 x HDMI™ port**</p> <p>2 x USB4® (40Gbps) ports support USB Type-C® display outputs***</p> <p>* Graphics specifications may vary between CPU types. Please refer to AMD CPU specifications.</p> <p>** Supports 4K@60Hz as specified in HDMI 2.1.</p> <p>*** Supports max. 4K@60Hz as specified in DisplayPort 1.4a</p> <p>**** VGA resolution support depends on processors' or graphic cards' resolution.</p>
Expansion Slots	<p><b>AMD Ryzen™ 9000 &amp; 7000 Series Desktop Processors*</b></p> <p>2 x PCIe 5.0 x16 slots with Q-Release Slim (supports x16 or x8/x8** or x8/x4/x4 modes***)</p> <p><b>AMD Ryzen™ 8700 &amp; 8600 &amp; 8400 Series Desktop Processors**</b></p> <p>2 x PCIe 4.0 x16 slots****</p> <p><b>AMD Ryzen™ 8500 &amp; 8300 Series Desktop Processors*</b></p> <p>2 x PCIe 4.0 x16 slots*****</p> <p>* Please check PCIe bifurcation table on support site (<a href="https://www.asus.com/support/FAQ/1037507/">https://www.asus.com/support/FAQ/1037507/</a>).</p> <p>** When you use both PCIe16_1 and PCIe16_2, PCIe16_1 and PCIe16_2 will run x8.</p> <p>*** When M.2_2 and M.2_3 are enabled simultaneously, PCIe16_2 will be disabled.</p> <p>**** When M.2_3 are enabled, PCIe16_1 will run x8, and PCIe16_2 will run x4.</p> <p>***** Only supports PCIe16_1 &amp; total bandwidth for x8, PCIe16_2 will be disabled</p> <p>***** Only supports PCIe16_1 &amp; total bandwidth for x4, PCIe16_2 will be disabled</p> <p>***** To ensure compatibility of the device installed, please refer to <a href="https://www.asus.com/support/download-center">https://www.asus.com/support/download-center</a> for the list of supported peripherals.</p>

(continued on the next page)



# ROG CROSSHAIR X870E HERO specifications summary

Storage	<p>Supports 5 x M.2 slots and 1 x SlimSAS connector and 4 x SATA 6Gb/s ports*</p> <p><b>AMD Ryzen™ 9000 &amp; 7000 Series Desktop Processors</b></p> <ul style="list-style-type: none"> <li>- M.2_1 slot (Key M), type 2242/2260/2280 (supports PCIe 5.0 x4 mode)</li> <li>- M.2_2 slot (Key M), type 2242/2260/2280 (supports PCIe 5.0 x4 mode)***</li> <li>- M.2_3 slot (Key M), type 2242/2260/2280 (supports PCIe 5.0 x4 mode)***</li> </ul> <p><b>AMD Ryzen™ 8000 Series Desktop Processors**</b></p> <ul style="list-style-type: none"> <li>- M.2_1 slot (Key M), type 2242/2260/2280 (supports PCIe 4.0 x4 mode)</li> </ul> <p><b>AMD X870E Chipset</b></p> <ul style="list-style-type: none"> <li>- M.2_4 slot (Key M), type 2242/2260/2280 (supports PCIe 4.0 x4 mode)</li> <li>- M.2_5 slot (Key M), type 2280 (supports PCIe 4.0 x4 mode)</li> <li>- SlimSAS slot supports PCIe 4.0 x4 mode.</li> <li>- 4 x SATA 6Gb/s ports</li> </ul> <p>* AMD RAIDXpert2 Technology supports both PCIe RAID 0/1/5/10 and SATA RAID 0/1/5/10. RAID 5 Function is only supported by AMD Ryzen™ 9000 series CPU.</p> <p>** M.2_2 and M.2_3 are not supported by this processor.</p> <p>*** When M.2_2 and M.2_3 are enabled simultaneously, PCIe16_2 will be disabled.</p> <p>*** When M.2_3 is enabled, PCIe16_1 will run x8 and PCIe16_2 will run x4, M.2_2 will also be disabled.</p>
Ethernet	<p>1 x Intel® 2.5Gb Ethernet</p> <p>1 x Realtek 5Gb Ethernet</p> <p>ASUS LANGuard</p>
Wireless & Bluetooth®	<p><b>Wi-Fi 7*</b></p> <p>2x2 Wi-Fi 7 (802.11be)</p> <p>Supports 2.4/5/6GHz frequency band**</p> <p>Support Wi-Fi 7 320MHz bandwidth, up to 6.5Gbps transfer rate.</p> <p>Bluetooth® v5.4***</p> <p>* Wi-Fi features may vary depending on the operating system</p> <ul style="list-style-type: none"> <li>- For Windows 11, Wi-Fi 7 will require 24H2 or later version for full functions, Windows 11 21H2/22H2/23H2 only support Wi-Fi 6E.</li> <li>- For Windows 10, please note that no driver is available, refer to the Wi-Fi chipset vendor's website for details.</li> </ul> <p>** Wi-Fi 6GHz frequency band and bandwidth regulatory may vary between countries.</p> <p>*** The Bluetooth® version may vary, please refer to the Wi-Fi module manufacturer's website for the latest specifications.</p>

(continued on the next page)

## ROG CROSSHAIR X870E HERO specifications summary

<p><b>USB</b></p>	<p><b>Rear USB (Total 10 ports)</b>                  2 x USB4® (40Gbps) ports (2 x USB Type-C®)                  8 x USB 10Gbps ports (6 x Type-A + 2 x USB Type-C®)</p> <p><b>Front USB (Total 10 ports)</b>                  1 x USB 20Gbps (supports USB Type-C® with up to 60W PD/QC4+)**                  1 x USB 20Gbps connector (supports USB Type-C®)                  2 x USB 5Gbps headers support 4 additional USB 5Gbps ports                  2 x USB 2.0 headers support 4 additional USB 2.0 ports</p> <p>* USB Type-C® power delivery output: 5V/3.0A                  ** USB Type-C® power delivery output: 5V/9V/15V/20V max. 3.0A, PPS: 3.3-21V max. 3.0A</p>
<p><b>Audio</b></p>	<p><b>ROG SupremeFX 7.1 Surround Sound High Definition Audio CODEC ALC4082*</b></p> <ul style="list-style-type: none"> <li>- Impedance sense for front and rear headphone outputs</li> <li>- Supports: Jack-detection, Multi-streaming, Front Panel MIC Jack-retasking</li> <li>- High quality 120 dB SNR stereo playback output and 110 dB SNR recording input</li> <li>- Supports up to 32-Bit/384 kHz playback on front panel</li> </ul> <p><b>Audio Features</b></p> <ul style="list-style-type: none"> <li>- SupremeFX Shielding Technology</li> <li>- ESS® ES9219 QUAD DAC</li> <li>- Gold-plated audio jacks</li> <li>- Rear optical S/PDIF out port</li> <li>- Premium audio capacitors</li> </ul> <p>* A chassis with an HD audio module in the front panel is required to support 7.1 Surround Sound audio output.                  ** The LINE OUT port on the rear panel does not support spatial audio. If you wish to use spatial audio, make sure to connect your audio output device to the audio jack on the front panel of your chassis or use a USB interface audio device.</p>
<p><b>Back Panel I/O Ports</b></p>	<p>2 x USB4® (40Gbps) ports (2 x USB Type-C®)                  8 x USB 10Gbps ports (6 x Type-A + 2 x USB Type-C®)                  1 x HDMI™ port                  1 x Wi-Fi module                  1 x Intel® 2.5Gb Ethernet port                  1 x Realtek 5Gb Ethernet port                  2 x Gold-plated audio jacks                  1 x Optical S/PDIF out port                  1 x BIOS FlashBack™ button                  1 x Clear CMOS button</p>

*(continued on the next page)*

## ROG CROSSHAIR X870E HERO specifications summary

<b>Internal I/O Connectors</b>	<p><b>Fan and Cooling Related</b></p> <ul style="list-style-type: none"><li>1 x 4-pin CPU Fan header</li><li>1 x 4-pin CPU OPT Fan header</li><li>1 x 4-pin AIO Pump header</li><li>4 x 4-pin Chassis Fan headers</li><li>1 x W_PUMP+ header</li></ul> <p><b>Power Related</b></p> <ul style="list-style-type: none"><li>1 x 24-pin Main Power connector</li><li>2 x 8-pin +12V CPU Power connectors</li><li>1 x 8-pin PCIe Power connector</li></ul> <p><b>Storage Related</b></p> <ul style="list-style-type: none"><li>5 x M.2 slots (Key M)</li><li>1 x SlimSAS connector</li><li>4 x SATA 6Gb/s ports</li></ul> <p><b>USB</b></p> <ul style="list-style-type: none"><li>2 x USB 20Gbps connectors (support USB Type-C®)</li><li>2 x USB 5Gbps headers support 4 additional USB 5Gbps ports</li><li>2 x USB 2.0 headers support 4 additional USB 2.0 ports</li></ul> <p><b>Miscellaneous</b></p> <ul style="list-style-type: none"><li>3 x Addressable Gen2 headers</li><li>1 x Alteration PCIe mode switch</li><li>1 x FlexKey button</li><li>1 x Front Panel Audio header (F_AUDIO)</li><li>1 x ReTry button</li><li>1 x Start button</li><li>1 x 10-1 pin System Panel header</li><li>1 x Thermal Sensor header</li><li>1 x LN2 Mode jumper</li></ul>
<b>Special Features</b>	<p><b>Extreme OC Kit</b></p> <ul style="list-style-type: none"><li>- FlexKey button</li><li>- LN2 Mode</li><li>- ReTry button</li><li>- Start button</li></ul> <p><b>Extreme Engine Digi+</b></p> <ul style="list-style-type: none"><li>- 10K Black metallic capacitors</li><li>- MicroFine alloy choke</li></ul>

*(continued on the next page)*

# ROG CROSSHAIR X870E HERO specifications summary

<b>Special Features</b>	<p><b>ASUS Q-Design</b></p> <ul style="list-style-type: none"><li>- M.2 Q-Latch</li><li>- M.2 Q-Release</li><li>- M.2 Q-Slide</li><li>- Q-Release Slim (with PCIe SafeSlot)</li><li>- Q-Antenna</li><li>- Q-Code</li><li>- Q-Connector</li><li>- Q-Dashboard</li><li>- Q-LED (CPU [red], DRAM [yellow], VGA [white], Boot Device [yellow green])</li><li>- Q-Slot</li></ul> <p><b>ASUS Thermal Solution</b></p> <ul style="list-style-type: none"><li>- M.2 heatsink backplate</li><li>- M.2 heatsink</li><li>- VRM heatsink design</li><li>- Metal backplate</li></ul> <p><b>ASUS EZ DIY</b></p> <ul style="list-style-type: none"><li>- Backplate</li><li>- BIOS FlashBack™ button</li><li>- Clear CMOS button</li><li>- ProCool II</li><li>- Pre-mounted I/O shield</li><li>- SafeSlot</li><li>- SafeDIMM</li></ul> <p><b>Aura Sync</b></p> <ul style="list-style-type: none"><li>- Addressable Gen2 headers</li></ul> <p><b>Front Panel USB 20Gbps with Quick Charge 4+ Support</b></p> <ul style="list-style-type: none"><li>- Support: up to 60W fast charging and USB Wattage Watcher*</li><li>- Output: 5/9/15/20V max. 3.0A, PPS:3.3–21V max. 3.0A</li><li>- Compatible with PD3.0 and PPS</li></ul> <p>* To support 60W, please install the power cable to the 6-pin PCIe power connector or else only 27W will be supported.</p>
<b>Software Features</b>	<p><b>ROG Exclusive Software</b></p> <ul style="list-style-type: none"><li>- ROG CPU-Z</li><li>- Dolby Atmos</li><li>- Internet Security (1-year full version)</li><li>- Polymo Lighting II</li></ul>

*(continued on the next page)*

## ROG CROSSHAIR X870E HERO specifications summary

Software Features	<b>ASUS Exclusive Software</b>
	Armoury Crate
	- AIDA64 Extreme (1 year full version)
	- Aura Creator
	- Aura Sync
	- Fan Xpert 4 (with AI Cooling II)
	- GameFirst
	- HWiNFO
	- Power Saving
	ASUS DriverHub
	ASUS GlideX
	USB Wattage Watcher
	TurboV Core
WinRAR (40 Days Free Trial)	
Adobe Creative Cloud (Free Trial)	
<b>UEFI BIOS</b>	
AI Overclocking Guide	
ASUS EZ DIY	
- ASUS CrashFree BIOS 3	
- ASUS EZ Flash 3	
- ASUS UEFI BIOS EZ Mode	
- ASUS MyHotkey	
FlexKey	
<b>BIOS</b>	256Mb Flash ROM, UEFI AMI BIOS
<b>BIOS CAP Filename</b>	<b>ROG CROSSHAIR X870E HERO: A5558.cap</b>
<b>Manageability</b>	WOL by PME, PXE
<b>Operating System</b>	Windows 11
<b>Form Factor</b>	ATX Form Factor 12 inch x 9.6 inch (30.5 cm x 24.4 cm)

**NOTE:** Specifications are subject to change without notice. Please refer to the ASUS website for the latest specifications.

## Package contents

Check your motherboard package for the following items.

Motherboard	1 x ROG CROSSHAIR X870E HERO motherboard
Cables	1 x ARGB RGB extension cable 4 x SATA 6Gb/s cables
Miscellaneous	1 x ASUS WiFi Q-Antenna 1 x Q-connector 2 x M.2 Q-Latch package 3 x M.2 Q-Slide package 5 x M.2 rubber package 1 x ROG stickers 1 x ROG thank you card 1 x ROG Bottle Opener
Installation Media	1 x USB drive with utilities and drivers
Documentation	1 x Quick Start Guide

---

**NOTE:**

- If any of the above items is damaged or missing, contact your retailer.
  - Items not listed in the Package contents list above are purchased separately and do not come bundled with your motherboard package.
-

# Connectors with shared bandwidth

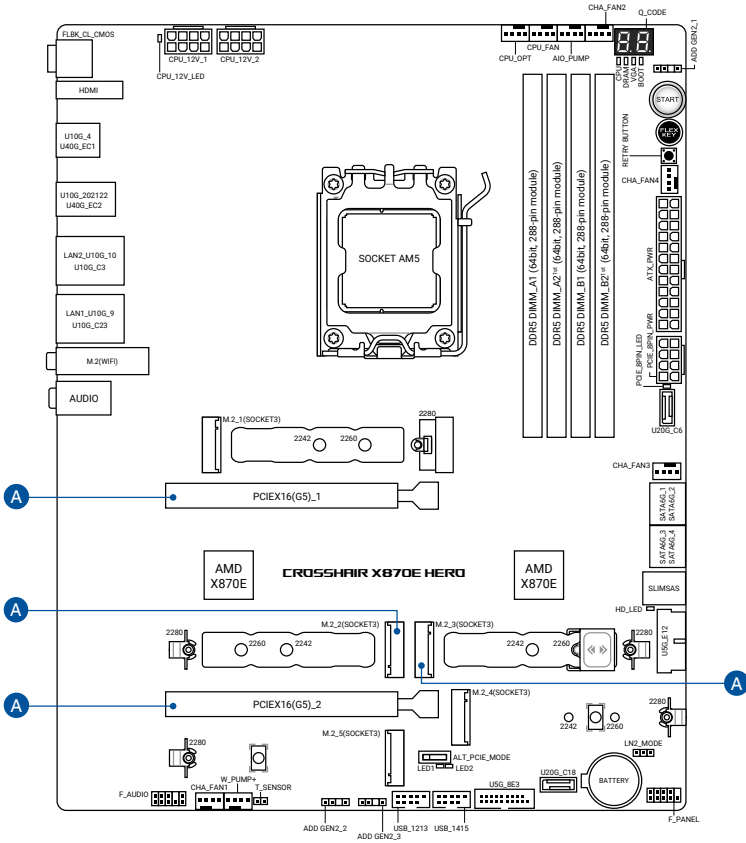

Configuration	1	2	3	4	
A	PCIEX16(G5)_1	x16	x8	x8	x8
	PCIEX16(G5)_2	-	x8	-	x4
	M.2_2 (CPU attached)	-	-	x4	-
	M.2_3 (CPU attached)	-	-	x4	x4





# Product Introduction

## 1.1 Before you proceed

Take note of the following precautions before you install motherboard components or change any motherboard settings.

---

**CAUTION!**

- Unplug the power cord from the wall socket before touching any component.
- Before handling components, use a grounded wrist strap or touch a safely grounded object or a metal object, such as the power supply case, to avoid damaging them due to static electricity.
- Hold components by the edges to avoid touching the ICs on them.
- Whenever you uninstall any component, place it on a grounded antistatic pad or in the bag that came with the component.
- Before you install or remove any component, ensure that the power supply is switched off or the power cord is detached from the power supply. Failure to do so may cause severe damage to the motherboard, peripherals, or components.

---

**NOTE:** The pin definitions in this chapter are for reference only. The pin names depend on the location of the header/jumper/connector.

---

# 1.2 Motherboard layout

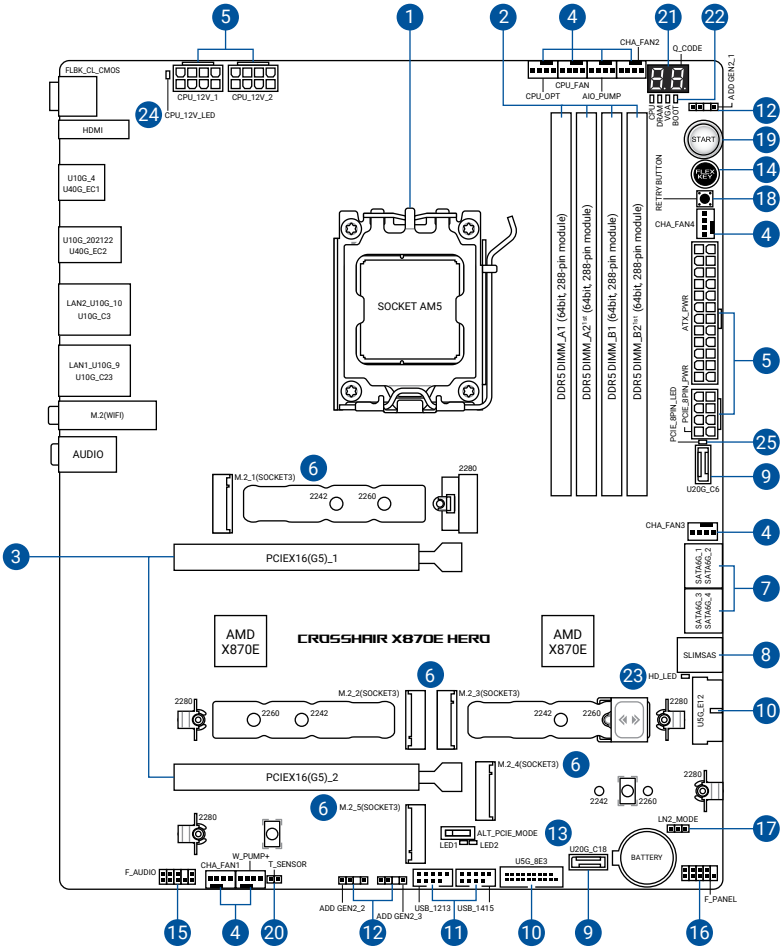

## Layout contents

1. CPU socket
2. DIMM slots
3. Expansion slots
4. Fan and Pump headers
5. Power connectors
6. M.2 slot
7. SATA 6Gb/s port
8. SlimSAS port
9. USB 20Gbps Type-C® Front Panel connector
10. USB 5Gbps header
11. USB 2.0 header
12. Addressable Gen2 header
13. Alteration PCIe Mode switch
14. FlexKey button
15. Front Panel Audio header
16. Front Panel System header
17. LN2 Mode jumper
18. ReTry button
19. Start button
20. Thermal Sensor header
21. Q-Code LED
22. Q-LEDs
23. Storage Device Activity LED
24. 8-pin CPU Power Plug LED
25. 8-pin PCIE Power Plug LED

## 1. CPU socket

The motherboard comes with a Socket AM5 designed for AMD Ryzen™ 9000 & 8000 & 7000 Series Desktop Processors.

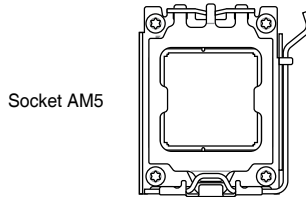

---

### CAUTION!

- The AM5 socket has a different pinout design. Ensure that you use a CPU designed for the AM5 socket.
  - The CPU fits in only one correct orientation. DO NOT force the CPU into the socket to prevent bending the connectors on the socket and damaging the CPU.
  - Ensure that all power cables are unplugged before installing the CPU.
  - Upon purchase of the motherboard, ensure that the PnP cap is on the socket and the socket contacts are not bent. Contact your retailer immediately if the PnP cap is missing, or if you see any damage to the PnP cap/socket contacts/motherboard components. ASUS will shoulder the cost of repair only if the damage is shipment/transit-related.
  - Keep the cap after installing the motherboard. ASUS will process Return Merchandise Authorization (RMA) requests only if the motherboard comes with the cap on the AM5 socket.
  - The product warranty does not cover damage to the socket contacts resulting from incorrect CPU installation/removal, or misplacement/loss/incorrect removal of the PnP cap.
- 

## 2. DIMM slots

The motherboard comes with Dual Inline Memory Modules (DIMM) slots designed for DDR5 (Double Data Rate 5) memory modules.



---

**CAUTION!** A DDR5 memory module is notched differently from a DDR, DDR2, DDR3, or DDR4 module. DO NOT install a DDR, DDR2, DDR3, or DDR4 memory module to the DDR5 slot.

---

**NOTE:** *DRAM installation detection function:* The DRAM LED will detect if the memory modules have been installed in the recommended memory configuration slots as well as if the memory modules have been properly installed and seated in the memory slots once the motherboard is connected to a power supply. After the motherboard has been powered on, the DRAM LED will return to the original error checking procedure, regardless of the LED status prior to powering on.

---

## Recommended memory configurations

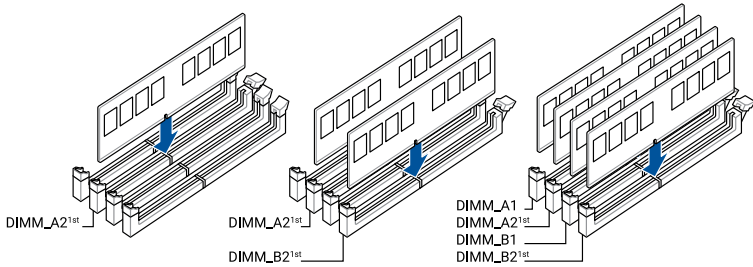

## Memory configurations

You may install ECC or Non-ECC DDR5 DIMMs into the DIMM sockets.

---

### NOTE:

- The default memory operation frequency is dependent on its Serial Presence Detect (SPD), which is the standard way of accessing information from a memory module. Under the default state, some memory modules for overclocking may operate at a lower frequency than the vendor-marked value.
  - For system stability, use a more efficient memory cooling system to support a full memory load or overclocking condition.
  - Always install the DIMMS with the same CAS Latency. For an optimum compatibility, we recommend that you install memory modules of the same version or data code (D/C) from the same vendor. Check with the vendor to get the correct memory modules.
  - Visit the ASUS website for the latest QVL.
-

### 3. Expansion slots

**CAUTION!** Unplug the power cord before adding or removing expansion cards. Failure to do so may cause you physical injury and damage motherboard components.

**NOTE:** To install a PCIe expansion card, please refer to the **Motherboard Installation Guide** on the ASUS support site.

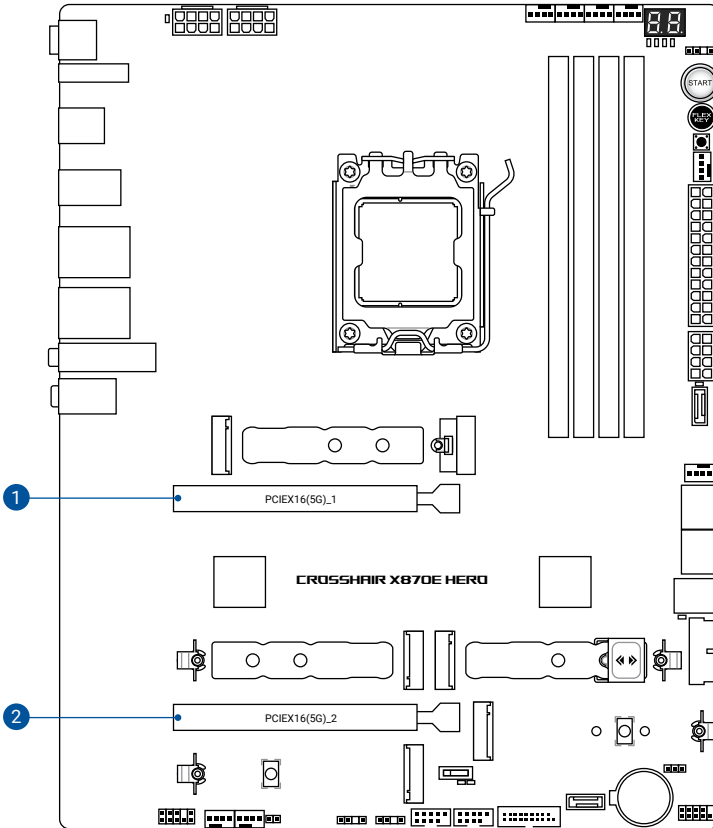

---

**NOTE:**

- For AMD Ryzen™ 9000 & 7000 Series Desktop Processors
    - When you use both PCIeX16\_1 and PCIeX16\_2, PCIeX16\_1 and PCIeX16\_2 will run x8.
    - When M.2\_3 are enabled, PCIeX16\_1 will run x8, and PCIeX16\_2 will run x4.
  - For AMD Ryzen™ 8700 & 8600 & 8400 Series Desktop Processors\*
    - Only supports PCIeX16\_1 & total bandwidth for x8, PCIeX16\_2 will be disabled.
  - For AMD Ryzen™ 8500 & 8300 Series Desktop Processors
    - Only supports PCIeX16\_1 & total bandwidth for x4, PCIeX16\_2 will be disabled.
  - When M.2\_2 and M.2\_3 are enabled simultaneously, PCIeX16\_2 will be disabled.
  - When M.2\_3 is enabled, PCIeX16\_1 will run x8 and PCIeX16\_2 will run x4, M.2\_2 will also be disabled.
-

## Using the Q-Release Slim PCIe slot

The PCIe slots on this motherboard feature the Q-Release slim feature allowing you to easily remove an expansion card installed to this PCIe slot, even when the expansion card may be blocking the PCIe push-latch, such as a graphics card. You may also remove an expansion card by pushing down on the PCIe push-latch.

### To release an expansion card on a Q-Release Slim PCIe slot:

Pull the front end of the expansion card upwards, this should release the expansion card from the Q-Release Slim PCIe slot, allowing you to remove the expansion card from the Q-Release Slim PCIe slot.

---

**NOTE:** The illustration below is for reference only. The motherboard and Q-Release Slim PCIe slot may differ between models, but the steps for using the Q-Release Slim PCIe slot remain the same.

---

**CAUTION!** Do not try to remove the expansion card by pulling the rear end of the expansion card upwards without pushing down on the PCIe push-latch first. Doing so with excessive force may cause damages to the motherboard.

---

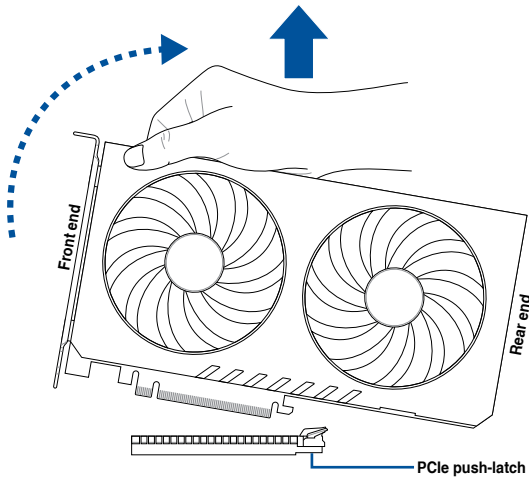



## 4. Fan and Pump headers

The Fan and Pump headers allow you to connect fans or pumps to cool the system.

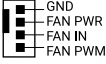
CPU_FAN	CHA_FAN1	
CPU_OPT	CHA_FAN2	
AIO_PUMP	CHA_FAN3	
W_PUMP+	CHA_FAN4	

---

### CAUTION!

- DO NOT forget to connect the fan cables to the fan headers. Insufficient air flow inside the system may damage the motherboard components. These are not jumpers! Do not place jumper caps on the fan headers!
  - Ensure the cable is fully inserted into the header.
- 

**IMPORTANT!** For water cooling kits, connect the pump connector to the **W\_PUMP+** or **AIO\_PUMP** header.

---

### NOTE:

- When connecting a single CPU fan, you may connect it to either the **CPU\_FAN** or **CPU\_OPT** header.
  - When connecting two CPU fans, ensure to connect the fans to the **CPU\_FAN** and the **CPU\_OPT** header, and make sure both fans are the same brand and model.
  - **W\_PUMP+** function support depends on water cooling device.
- 

Header	Max. Current	Max. Power	Default Speed	Shared Control
CPU_FAN	1A	12W	Q-Fan Controlled	A
CPU_OPT	1A	12W	Q-Fan Controlled	A
CHA_FAN1	1A	12W	Q-Fan Controlled	-
CHA_FAN2	1A	12W	Q-Fan Controlled	-
CHA_FAN3	1A	12W	Q-Fan Controlled	-
CHA_FAN4	1A	12W	Q-Fan Controlled	-
AIO_PUMP	1A	12W	Full-Speed	-
W_PUMP+	3A	36W	Full Speed	-

## 5. Power connectors

These Power connectors allow you to connect your motherboard to a power supply. The power supply plugs are designed to fit in only one orientation, find the proper orientation and push down firmly until the power supply plugs are fully inserted.

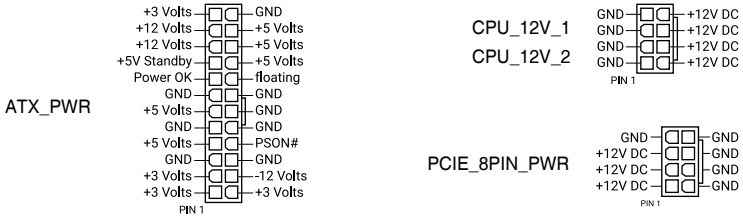

---

**CAUTION!** Ensure to connect the 8-pin power plug, or connect both the 8-pin power plugs.

---

### NOTE:

- We recommend that you use a PSU with a higher power output when configuring a system with more power-consuming devices. The system may become unstable or may not boot up if the power is inadequate.
  - If you want to use two or more high-end PCI Express x16 cards, we recommend using a PSU with 900W~1200W power or above to ensure the system stability.
  - The **PCIE\_8PIN\_PWR** connector provides power for PD3.0 support for the USB 20Gbps Type-C® Front Panel connector.
-

## 6. M.2 slot

The M.2 slot allows you to install M.2 devices such as M.2 SSD modules.

M.2\_1(SOCKET3)  
M.2\_2(SOCKET3)  
M.2\_3(SOCKET3)  
M.2\_4(SOCKET3)  
M.2\_5(SOCKET3)



### NOTE:

- **AMD Ryzen™ 9000 & 7000 Series Desktop Processors:**
  - M.2\_1 slot (Key M), type 2242/2260/2280 (supports PCIe 5.0 x4 mode)
  - M.2\_2 slot (Key M), type 2242/2260/2280 (supports PCIe 5.0 x4 mode)
  - M.2\_3 slot (Key M), type 2242/2260/2280 (supports PCIe 5.0 x4 mode)
- **AMD Ryzen™ 8000 Series Desktop Processors:**
  - M.2\_1 slot (Key M), type 2242/2260/2280 (supports PCIe 4.0 x4 mode)
  - M.2\_2 and M.2\_3 slot (Key M) not supported by this processor.
- **AMD X870E Chipset:**
  - M.2\_4 slot (Key M), type 2242/2260/2280 (supports PCIe 4.0 x4 mode)
  - M.2\_5 slot (Key M), type 2280 (supports PCIe 4.0 x4 mode)
- When M.2\_2 and M.2\_3 are enabled simultaneously, PCIEX16\_2 will be disabled.
- When M.2\_3 is enabled, PCIEX16\_1 will run x8 and PCIEX16\_2 will run x4, M.2\_2 will also be disabled.
- AMD RAIDXpert2 Technology supports both PCIe RAID 0/1/5/10 and SATA RAID 0/1/5/10. RAID 5 Function is only supported by AMD Ryzen™ 9000 series CPU.

## 7. SATA 6Gb/s port

The SATA 6Gb/s port allows you to connect SATA devices such as optical disc drives and hard disk drives via a SATA cable.

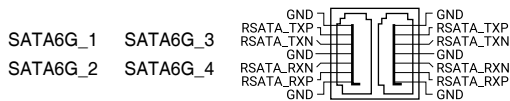

### NOTE:

- If you installed SATA storage devices to the **SATA6G\_1-4** ports, you can create RAID configurations through the onboard AMD X870E chipset.
- To install a SATA device, please refer to the **Motherboard Installation Guide** on the ASUS support site.
- Before creating a RAID set, refer to the **RAID Configuration Guide**. You can download the **RAID Configuration Guide** from the ASUS website.

## 8. SlimSAS port

The SlimSAS port allows you to connect NVMe storage devices.



---

**NOTE:** AMD RAIDxpert2 Technology supports both PCIe RAID 0/1/5/10 and SATA RAID 0/1/5/10. RAID 5 Function is only supported by AMD Ryzen™ 9000 series CPU.

---

## 9. USB 20Gbps Type-C® Front Panel connector

The USB 20Gbps Type-C® connector allows you to connect a USB 20Gbps Type-C® module for additional USB 20Gbps ports on the front panel. The USB 20Gbps Type-C® connector provides data transfer speeds of up to 20 Gb/s and PD 3.0 support for up to DC 20V/3A 60W fast charging technology.

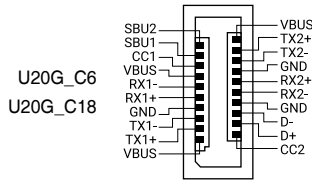

---

**NOTE:**

- For PD 3.0 / QC 4+ support, ensure to connect the **PCIE\_8PIN\_PWR** connector.
  - PD 3.0 up to DC 20V/3A 60W fast charging technology is only supported on CC Logic Devices.
  - In S5 (Soft Off State) PD 3.0 and QC 4+ only provide power delivery of up to 10W.
- 

## 10. USB 5Gbps header

The USB 5Gbps header allows you to connect a USB 5Gbps module for additional USB 5Gbps ports. The USB 5Gbps header provides data transfer speeds of up to 5 Gb/s.

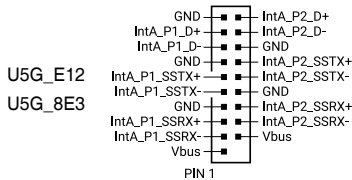

## 11. USB 2.0 header

The USB 2.0 header allows you to connect a USB module for additional USB 2.0 ports. The USB 2.0 header provides data transfer speeds of up to 480 Mb/s.

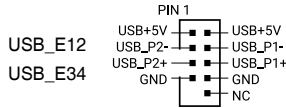

---

**CAUTION!** DO NOT connect a 1394 cable to the USB connectors. Doing so will damage the motherboard!

---

## 12. Addressable Gen2 header

The Addressable Gen2 header allows you to connect individually addressable RGB (ARGB) WS2812B LED strips or WS2812B based LED strips.

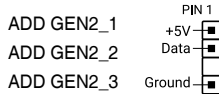

---

**CAUTION!** Before you install or remove any component, ensure that the power supply is switched off or the power cord is detached from the power supply. Failure to do so may cause severe damage to the motherboard, peripherals, or components.

---

### NOTE:

- The Addressable Gen2 header supports addressable RGB LED strips (5V/Data/Ground), with a maximum power rating of 3A (5V). Additionally, the addressable header on this board can support up to 120 LEDs per header in Gen1 mode, or a combined maximum of 500 LEDs in Gen2 mode.
  - Actual lighting and color will vary with LED strip.
  - If your LED strip does not light up, check if the addressable RGB LED strip is connected in the correct orientation, and the 5V connector is aligned with the 5V header on the motherboard.
  - The addressable RGB LED strip will only light up when the system is powered on.
-

### 13. Alteration PCIe Mode switch

The Alteration PCIe Mode switch allows you to switch the PCIe signal which comes from the CPU from between Gen4 or Gen3 for the PCIe slot.

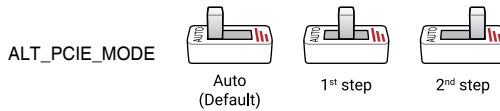

#### NOTE:

- When the Alteration PCIe Mode switch is set to **Auto**, the PCIe signal from the CPU will be the default setting.
- When the Alteration PCIe Mode switch is set to **1st step**, the PCIe signal from the CPU will be Gen4, and LED1 will light up green.
- When the Alteration PCIe Mode switch is set to **2nd step**, the PCIe signal from the CPU will be Gen3, and LED2 will light up yellow.
- The nearby LEDs indicate which PCIe mode is currently selected.

### 14. FlexKey button (Reset)

Press the FlexKey button to reboot the system. You may also configure the button and assign a quick access feature such as activating Safe Boot or turning Aura lighting on or off to the button.

FLEXKEY



### 15. Front Panel Audio header

The Front Panel Audio header is for a chassis-mounted front panel audio I/O module that supports HD Audio. Connect one end of the front panel audio I/O module cable to this header.

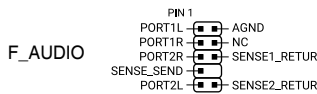

## 16. Front Panel System header

The Front Panel System header supports several chassis-mounted functions.

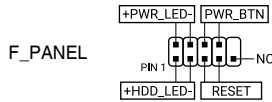

- **System Power LED header (+PWR\_LED-)**

The 2-pin header allows you to connect the System Power LED. The System Power LED lights up when the system is connected to a power source, or when you turn on the system power, and blinks when the system is in sleep mode.

- **Storage Device Activity LED header (+HDD\_LED-)**

The 2-pin header allows you to connect the Storage Device Activity LED. The Storage Device Activity LED lights up or blinks when data is read from or written to the storage device or storage device add-on card.

- **System Warning Speaker header (SPEAKER)**

The 4-pin header allows you to connect the chassis-mounted system warning speaker. The speaker allows you to hear system beeps and warnings.

- **Power Button/Soft-off Button header (PWR\_BTN)**

The 3-1 pin header allows you to connect the system power button. Press the power button to power up the system, or put the system into sleep or soft-off mode (depending on the operating system settings).

- **Reset button header (RESET)**

The 2-pin header allows you to connect the chassis-mounted reset button. Press the reset button to reboot the system.

## 17. LN2 Mode jumper

Set to pins 2-3 to optimize the motherboard to remedy the cold-boot bug during POST and help the system boot successfully.

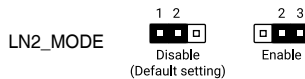

## 18. ReTry button

The ReTry button is specially designed for overclockers and is most useful during the booting process where the Reset button is rendered useless. Press this button to force the system to reboot while retaining the same settings to be retried in quick succession to achieve a successful POST.

RETRY\_BUTTON



## 19. Start button

Press the Start button to power up the system, or put the system into sleep or soft-off mode (depending on the operating system settings).

START



---

**NOTE:** The button also lights up when the system is plugged to a power source, indicating that you should shut down the system and unplug the power cable before removing or installing any motherboard component.

---

## 20. Thermal Sensor header

The Thermal Sensor header allows you to connect a sensor to monitor the temperature of the devices and the critical components inside the motherboard. Connect the thermal sensor and place it on the device or the motherboard's component to detect its temperature.

T\_SENSOR

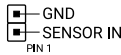

## 21. Q-Code LED

The Q-Code LED design provides you with a 2-digit error code that displays the system status.

Q\_CODE



---

**NOTE:**

- The Q-Code LEDs provide the most probable cause of an error code as a starting point for troubleshooting. The actual cause may vary from case to case.
  - Please refer to the Q-Code table in the **Appendix** section for more details.
-



## 22. Q-LEDs

The Q-LEDs check key components (CPU, DRAM, VGA, and booting devices) during the motherboard booting process. If an error is found, the critical component's LED stays lit up until the problem is solved.

CPU (RED)	■
DRAM (YELLOW)	■
VGA (WHITE)	□
BOOT (GREEN)	■

---

### NOTE:

- The Q-LEDs provide the most probable cause of an error code as a starting point for troubleshooting. The actual cause may vary from case to case.
  - *DRAM installation detection function:* The DRAM LED will detect if the memory modules have been installed in the recommended memory configuration slots as well as if the memory modules have been properly installed and seated in the memory slots once the motherboard is connected to a power supply. After the motherboard has been powered on, the DRAM LED will return to the original error checking procedure, regardless of the LED status prior to powering on.
- 

## 23. Storage Device Activity LED

The Storage Device Activity LED lights up or blinks when data is read from or written to the storage device or storage device add-on card.

HD\_LED □

## 24. 8-pin CPU Power Plug LED

The 8-pin CPU Power Plug LED lights up to indicate that the 8-pin CPU power plug is not connected.

CPU\_12V\_LED □

## 25. 8-pin PCIe Power Plug LED

The 8-pin PCIe Power Plug LED lights up to indicate if the 8-pin power plug **PCI\_E\_8PIN\_PWR** is not connected.

PLUG\_8PIN\_PCIE □

## 1.3 Motherboard rear and audio connections

### 1.3.1 Rear I/O connection

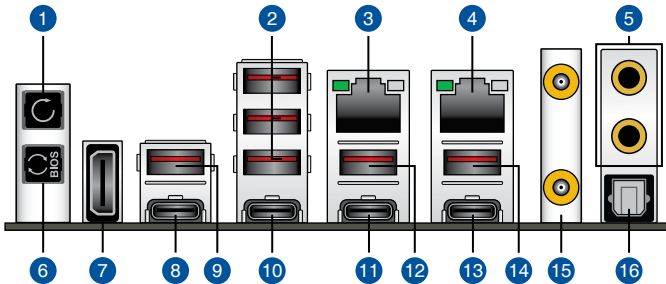

#### Rear panel connectors

- |     |  |
|-----|--|
| 1.  | Clear CMOS button (CLR_CMOS). Press this button to clear the BIOS setup information only when the systems hangs due to overclocking. |
| 2.  | USB 10Gbps (Red) Type-A ports 20, 21, and 22   |
| 3.  | Realtek 5Gb Ethernet port*   |
| 4.  | Intel® 2.5Gb Ethernet port*  |
| 5.  | Gold-plated audio jacks**  |
| 6.  | BIOS FlashBack™ button   |
| 7.  | HDMI™ port   |
| 8.  | USB 40Gbps (USB4®) with ASMedia ASM4242 controller port EC1  |
| 9.  | USB 10Gbps (Red) Type-A port 4   |
| 10. | USB 40Gbps (USB4®) with ASMedia ASM4242 controller port EC2  |
| 11. | USB 10Gbps Type-C® port C11  |
| 12. | USB 10Gbps (Red) Type-A port 10  |
| 13. | USB 10Gbps Type-C® port C23  |
| 14. | USB 10Gbps (Red) Type-A port 9   |
| 15. | Wi-Fi module   |
| 16. | Optical S/PDIF OUT port  |

\* and \*\*: Refer to the tables under LAN port LEDs, and Audio I/O connections sections.

**NOTE:** We strongly recommend that you connect your devices to ports with matching data transfer rate. For example connecting your USB 5Gbps devices to USB 5Gbps ports for faster and better performance for your devices.

## 1.3.2 LAN port LEDs

### Realtek 5Gb Ethernet port LED indications

Activity Link LED		Speed LED	
Status	Description	Status	Description
OFF	No link	OFF	No Link
GREEN	Linked	GREEN	5 Gbps connection
BLINKING	Data activity	ORANGE	2.5 Gbps / 1 Gbps / 10 Mbps / 100 Mbps connection

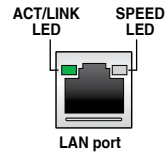

### Intel® 2.5Gb Ethernet port LED indications

Activity Link LED		Speed LED	
Status	Description	Status	Description
OFF	No link	OFF	No link
GREEN	Linked	OFF	100 Mbps / 10 Mbps connection
BLINKING	Data activity	GREEN	2.5 Gbps connection
		ORANGE	1 Gbps connection

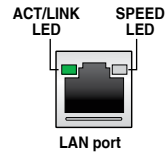

## 1.3.3 Audio I/O connections

### Audio 2, 4, 5.1 or 7.1-channel configuration

Port	2-channel	4-channel	5.1-channel	7.1-channel
<b>Rear panel</b>				
LINE OUT	Front Speaker Out	Front Speaker Out	Front Speaker Out	Front Speaker Out
MIC IN	-	-	Center/ Subwoofer	Center/ Subwoofer
<b>Front panel</b>				
HEADPHONE (Lime)	-	-	-	Side Speaker Out
MIC IN (Pink)	-	Rear Speaker Out	Rear Speaker Out	Rear Speaker Out

**NOTE:** A chassis with an HD audio module in the front panel is required to support 7.1 Surround Sound audio output.

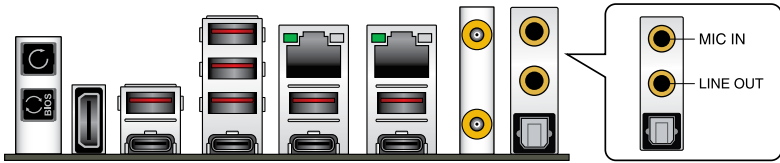

## Connect to Headphone and Mic

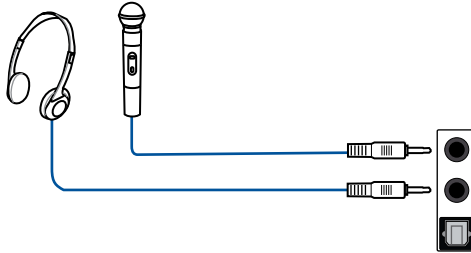

---

**NOTE:** The LINE OUT port on the rear panel does not support spatial audio. If you wish to use spatial audio, make sure to connect your audio output device to the audio jack on the front panel of your chassis or use a USB interface audio device.

---

## Connect to 2-channel Speakers

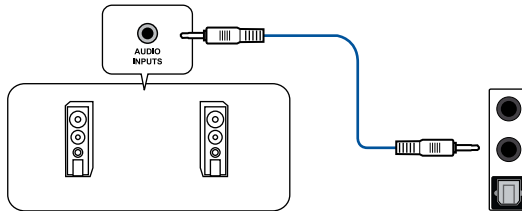

### Connect to 4-channel Speakers

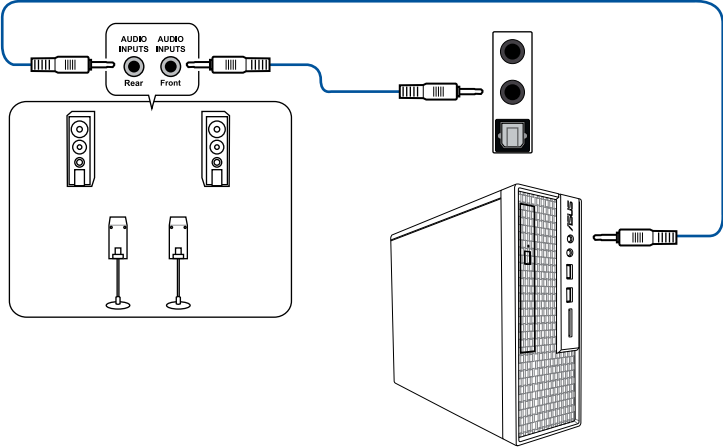

### Connect to 5.1-channel Speakers

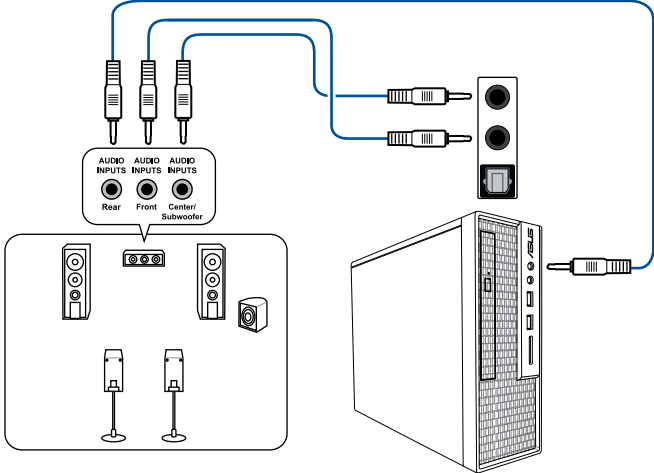

# Connect to 7.1-channel Speakers

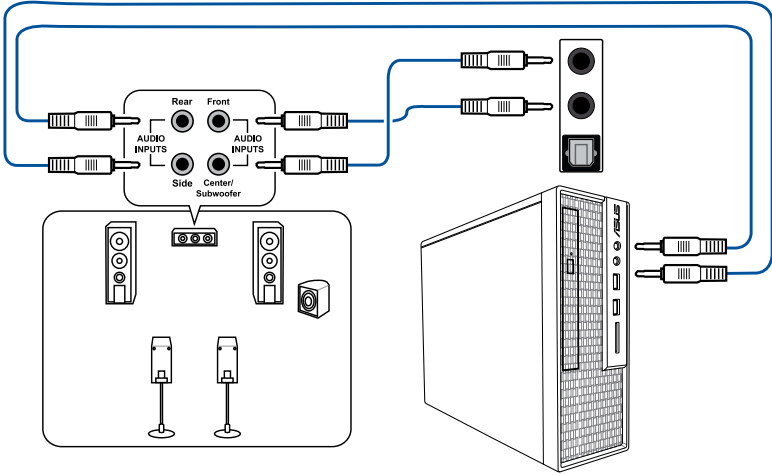

# Basic Setup

---

**NOTE:** The installation diagrams in this section are for reference only. The motherboard layout may vary with models, but the installation steps are the same for all models.

---

## 2.1 CPU installation

---

### CAUTION!

- Ensure that you use a CPU designed for the AM5 socket. The CPU fits in only one correct orientation. DO NOT force the CPU into the socket to prevent bending the pins and damaging the CPU
  - Ensure that all power cables are unplugged before installing the CPU.
  - Upon purchase of the motherboard, ensure that the PnP cap is on the socket and the socket contacts are not bent. Contact your retailer immediately if the PnP cap is missing, or if you see any damage to the PnP cap/socket contacts/motherboard components. ASUS will shoulder the cost of repair only if the damage is shipment/transit-related.
- 

**IMPORTANT!** Install a heatsink or AIO cooler after installing the CPU. Please refer to the **Motherboard Installation Guide** on the ASUS support site, or to the user manual of the heatsink/AIO cooler for steps on installing the heatsink/AIO cooler.

---

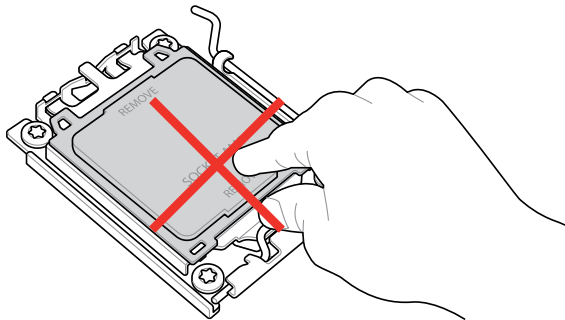

1

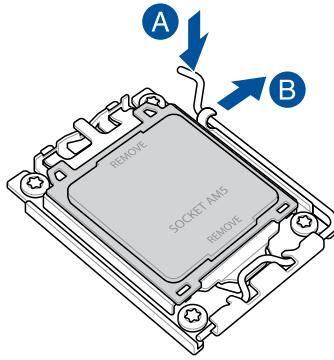

2

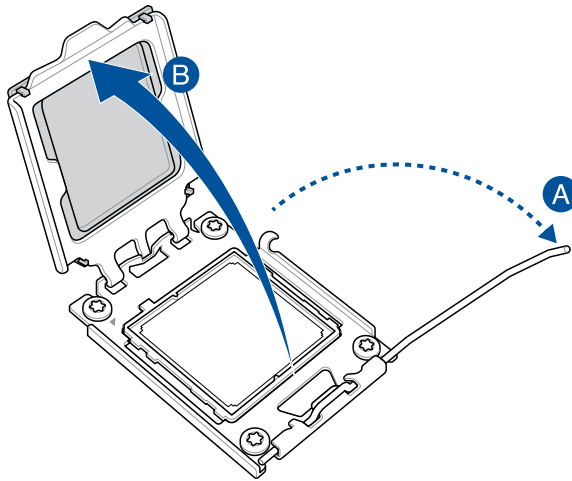



3

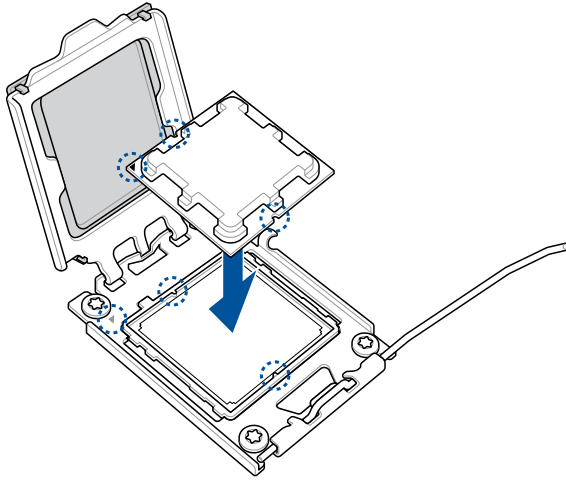

4

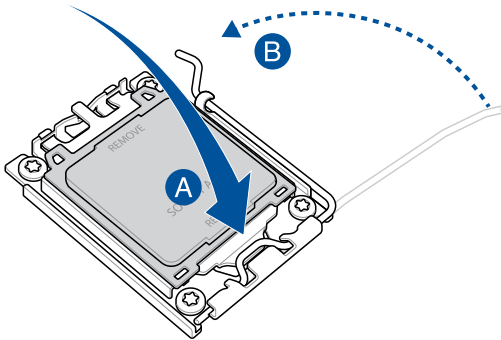

5

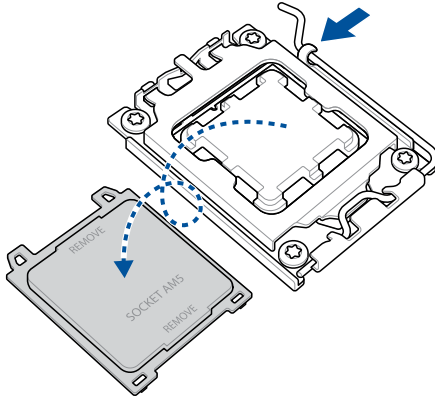

## 2.2 DIMM installation

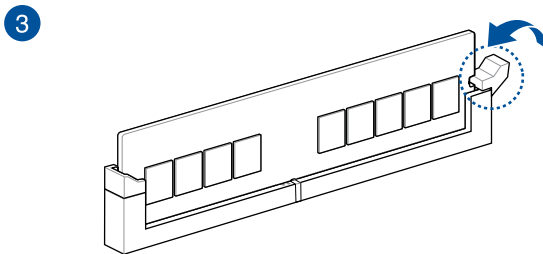
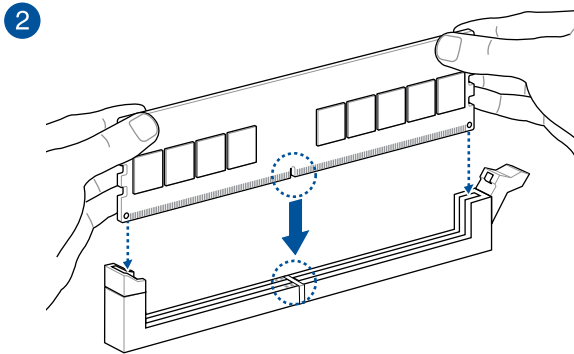
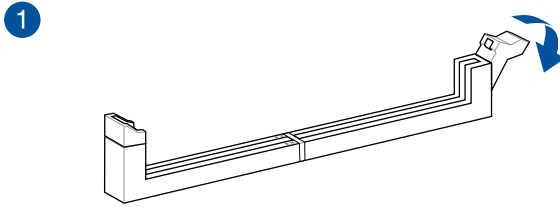

### DIMM removal

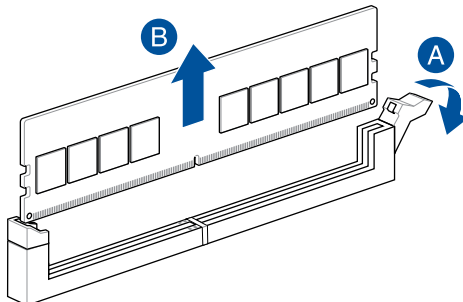

## 2.3 M.2 module installation

---

**NOTE:**

- The illustrations only show the installation steps for selected M.2 slots, the steps are the same for the other M.2 slots.
  - Use a Phillips screwdriver when removing or installing the screws or screw stands mentioned in this section.
  - If the thermal pad on the M.2 heatsink becomes damaged, we recommend replacing it with the bundled thermal pad or a thermal pad with a thickness of 1.25mm.
  - Supported M.2 type varies per motherboard.
- 

1. Press the tab downwards on the M.2 Q-Release to release the heatsink.

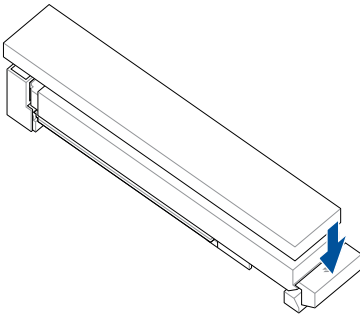

2. Pull the heatsink slightly outwards towards the tab, then lift and remove the heatsink.

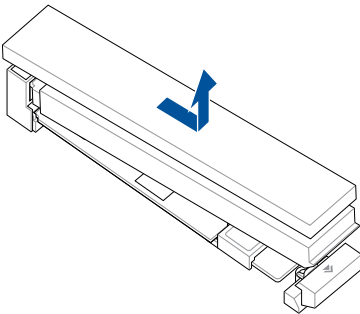

3. Loosen the screws from the other M.2 heatsink(s).
4. Lift and remove the heatsink(s).

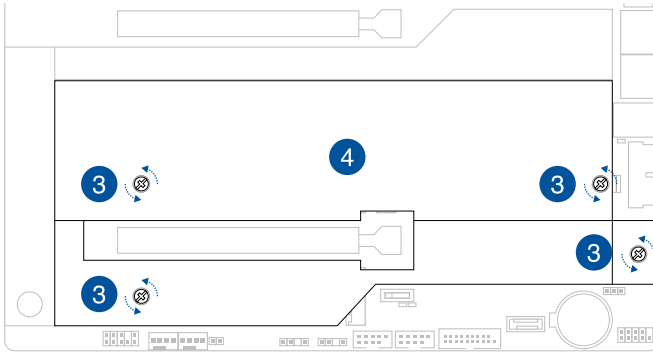

5. Install your M.2 module to your M.2 slot. The steps may differ between the different M.2 slots, please refer to the different installation steps below:

**Installing an 22110 M.2 module to 22110 length M.2 slot with backplate or 2280 M.2 module to 2280 length M.2 slot with backplate**

- A. (optional) If required, remove the pre-installed M.2 Q-Slide by pushing the M.2 Q-Slide all the way towards the M.2 slot then removing it from the M.2 backplate.

---

**NOTE:** Only 22110 length M.2 backplates come pre-installed with the M.2 Q-Slide.

---

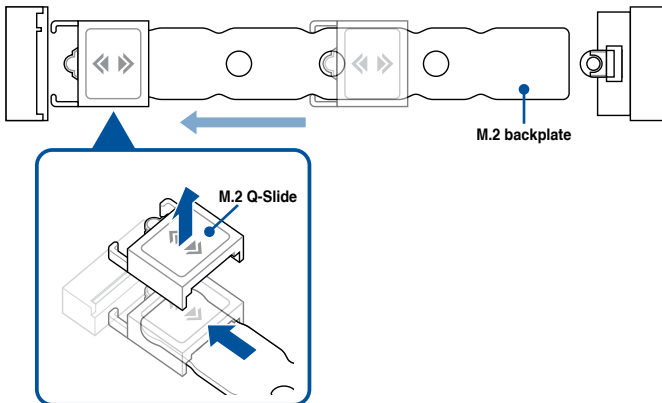

- B. (optional) Install the bundled M.2 rubber if you are installing a single sided M.2 module. DO NOT install the bundled M.2 rubber when installing a double-sided M.2 module.

**NOTE:**

- Only follow this step when the M.2 rubber comes bundled with your motherboard package.
- Install the bundled M.2 rubber to the 2260 M.2 length screw hole.

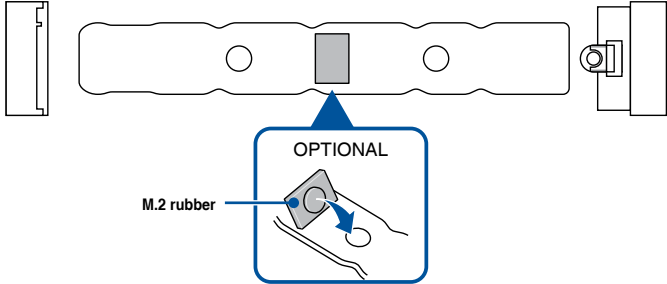

- C. Install your M.2 module to the M.2 slot.

**IMPORTANT!** Ensure that there is nothing obstructing your M.2 module when installing the M.2 module to the M.2 slot.

- D. Push the M.2 module down until it is secured by the M.2 Q-Latch.

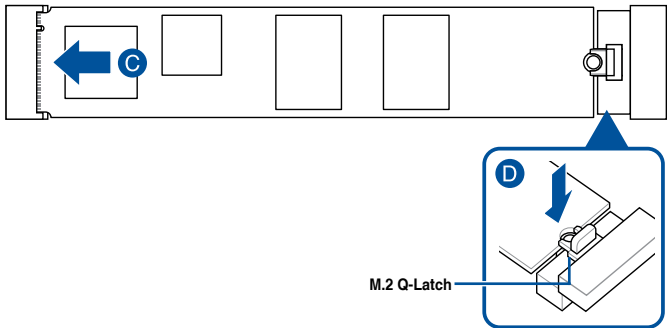

**Installing an 2280/2260/2242 M.2 module to M.2 slot with 22110 length M.2 backplate or 2260/2242 M.2 module to M.2 slot with 2280 length M.2 backplate**

- A. (optional) If required, install the bundled M.2 Q-Slide by attaching the M.2 Q-Slide to the end of the M.2 backplate closest to the M.2 slot, then pushing it along the M.2 backplate towards the M.2 Q-Latch.

**NOTE:** Only follow this step when:

- The M.2 Q-Slide comes bundled with your motherboard package.
- The M.2 Q-Slide is not pre-installed to the M.2 backplate.

- B. Push the M.2 Q-Slide to the M.2 length screw hole you wish to install your M.2 module to..

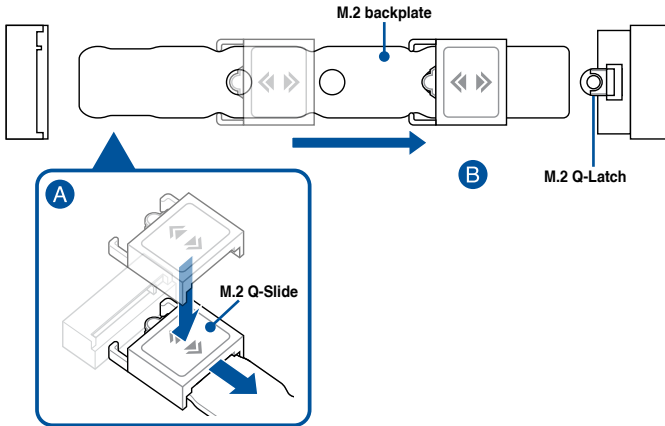

- C. (optional) Install the bundled M.2 rubber if you are installing a single sided M.2 module. DO NOT install the bundled M.2 rubber when installing a double-sided M.2 module.

**NOTE:**

- Only follow this step when:
  - Installing a 2280 or 2260 length M.2 module and
  - When the M.2 rubber comes bundled with your motherboard package.
- Install the bundled M.2 rubber to the:
  - 2260 M.2 length screw hole when installing a 2280 length M.2 module.
  - 2242 M.2 length screw hole when installing a 2260 length M.2 module.

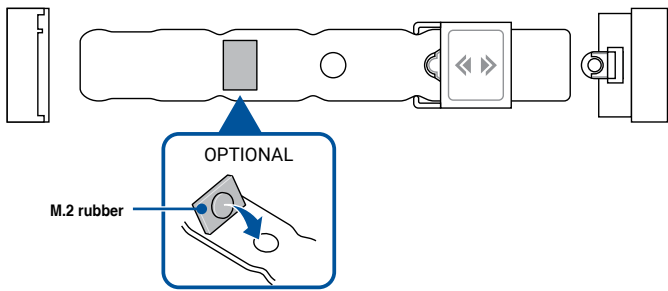

- D. Install your M.2 module to the M.2 slot.

**IMPORTANT!** Ensure that there is nothing obstructing your M.2 module when installing the M.2 module to the M.2 slot.

- E. Push the M.2 module down onto the M.2 Q-Slide until the M.2 module clicks into place and is secured by the M.2 M.2 Q-Slide.

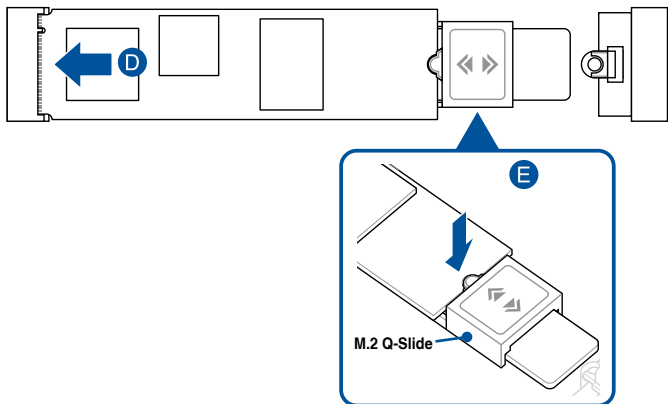

## Installing an M.2 module to M.2 slot without M.2 backplate

- A. (optional) If required, remove the pre-installed removable M.2 Q-Latch screw at the 2280 length screw hole.

---

**NOTE:** Only follow this step if a removable M.2 Q-Latch screw is pre-installed at the 2280 length screw hole and can be removed.

---

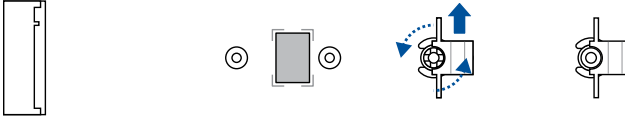

- B. (optional) Install the bundled M.2 rubber if you are installing a single sided M.2 module. DO NOT install the bundled M.2 rubber when installing a double-sided M.2 module. The rubber installed by default is compatible with double sided M.2 modules.

---

**NOTE:** Only follow this step if installing a 22110 or 2280 length M.2 module and when the M.2 rubber comes bundled with your motherboard package.

---

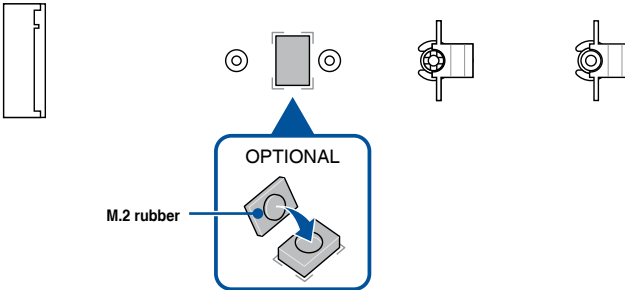

- C. (optional) Install the M.2 Q-Latch to the M.2 length screw hole you wish to install your M.2 module to.

---

**NOTE:** You can use a bundled M.2 Q-Latch screw or a pre-installed removable M.2 Q-Latch screw.

---

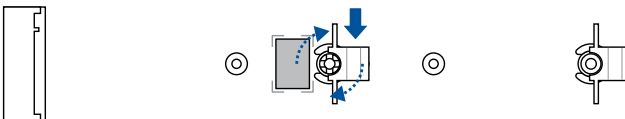



- D. Install your M.2 module to the M.2 slot.

---

**IMPORTANT!** Ensure that there is nothing obstructing your M.2 module when installing the M.2 module to the M.2 slot.

---

- E. Push the M.2 module down until it is secured by the M.2 Q-Latch.

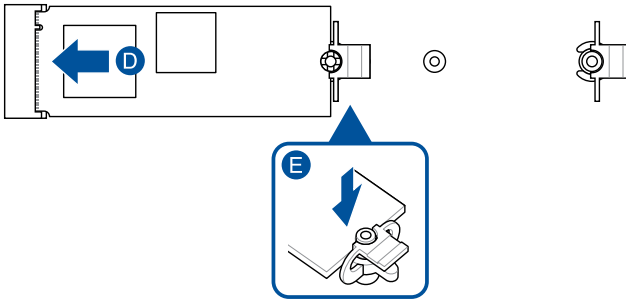

6. Remove the plastic film from the thermal pads on the bottom of the heatsink.

---

**NOTE:** If the thermal pad on the M.2 heatsink becomes damaged, we recommend replacing it with the bundled thermal pad or a thermal pad with a thickness of 1.25mm.

---

7. Slide the heatsink into the slot on the end with the M.2 slot, then press the heatsink down until it clicks into place and is secured.

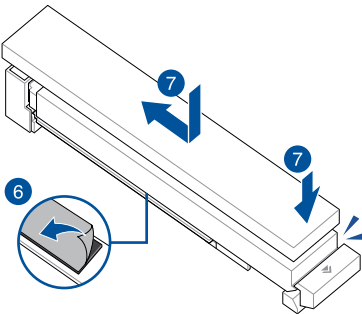

8. Remove the plastic film from the thermal pads on the bottom of the other heatsink(s).

---

**NOTE:** If the thermal pad on the M.2 heatsink becomes damaged, we recommend replacing it with the bundled thermal pad or a thermal pad with a thickness of 1.25mm.

---

9. Replace the heatsink(s).
10. Secure the heatsink(s) using the screws on the heatsink(s).

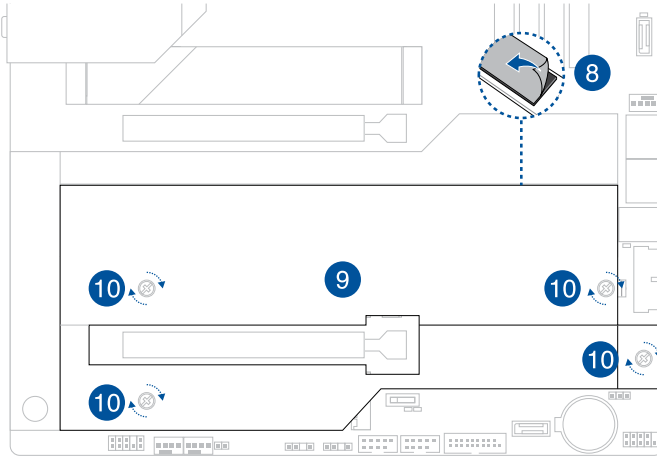

## 2.4 Motherboard installation

1. (on selected models) Install the bundled I/O Shield to the chassis rear I/O panel.

---

**NOTE:** Only install the I/O Shield if your motherboard does not have a pre-installed I/O shield.

---

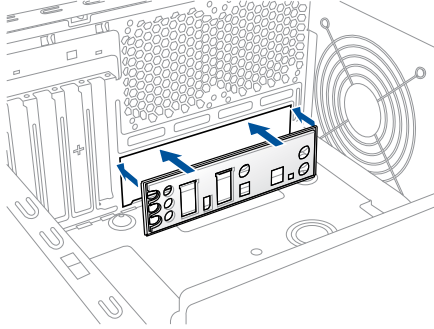

2. Place the motherboard into the chassis, ensuring that its rear I/O ports are aligned to the chassis' rear I/O panel.
3. Place nine (9) screws into the holes indicated by circles to secure the motherboard to the chassis.

---

**NOTE:** This instruction is for reference only, please place the amount of screws according to your installation situation.

---

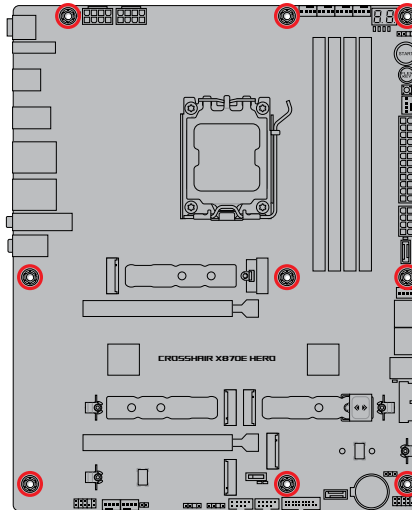

---

**CAUTION!** DO NOT over tighten the screws! Doing so can damage the motherboard.

---

## 2.5 ASUS WiFi Q-Antenna installation

### Installing the ASUS WiFi Q-Antenna

Connect the bundled ASUS WiFi Q-Antenna connector to the Wi-Fi ports at the back of the chassis.

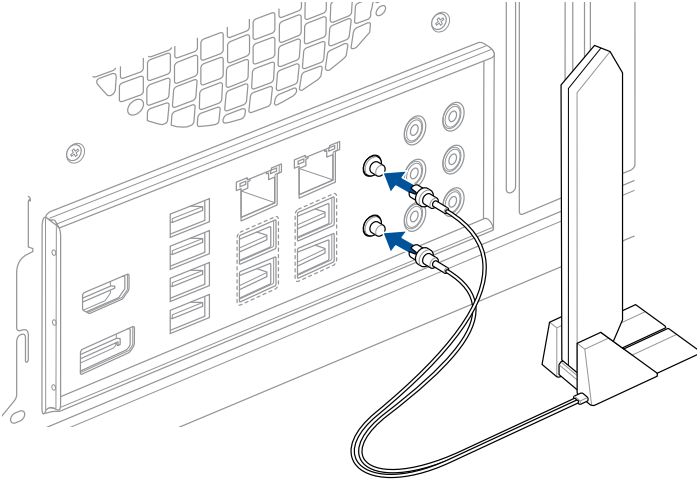

---

#### CAUTION!

- Ensure to hold tightly onto the connector when removing the antenna connector from the Wi-Fi ports, and refrain from attempting to remove the antenna connector from the Wi-Fi ports by pulling on the antenna connector cable.
- The antenna can only be extended to a right angle (90°). Do not force the antenna into an angle more than 90°, doing so may cause damages to the ASUS WiFi Q-Antenna.

---

#### IMPORTANT!

- Ensure that the ASUS WiFi Q-Antenna is securely installed to the Wi-Fi ports.
- Ensure that the antenna is at least 20 cm away from all persons.

---

**NOTE:** The illustration above is for reference only. The I/O port layout may vary with models, but the WiFi Q-Antenna installation procedure is the same for all models.

---

### Using ASUS WiFi Q-Antenna functions

The ASUS WiFi Q-Antenna features a variety of wireless functions, you can learn more about these feature and how to use them in the **ASUS WiFi Q-Antenna** tab in Armoury Crate.

---

**NOTE:** The ASUS WiFi Q-Antenna function in Armoury Crate is only supported on the bundled antenna and Wi-Fi module.

---

## 2.6 BIOS FlashBack™

BIOS FlashBack™ allows you to easily update the BIOS without entering the existing BIOS or operating system.

### To use BIOS FlashBack™:

1. Visit <https://www.asus.com/support/> and download the latest BIOS version for this motherboard.
2. Launch the **BIOSRenamer.exe** application to automatically rename the file or manually rename the file to the BIOS CAP filename specified in the **Specifications summary** section, then copy it to your USB storage device.

---

**NOTE:** The **BIOSRenamer.exe** application is zipped together with your BIOS file when you download a BIOS file for a BIOS FlashBack™ compatible motherboard.

---

3. Plug the 24-pin power connector to the motherboard and turn on the power supply (no need to power on the system). Insert the USB storage device to the USB port with BIOS FlashBack™ function.
4. Press the BIOS FlashBack™ button for three (3) seconds until the BIOS FlashBack™ LED blinks three times, indicating that the BIOS FlashBack™ function is enabled.

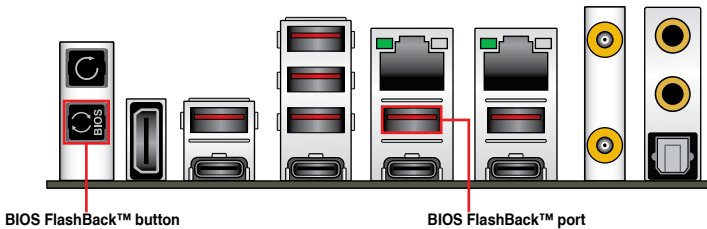

5. Wait until the light goes out, indicating that the BIOS updating process is completed.

---

**NOTE:** For more BIOS update utilities in BIOS setup, refer to **BIOS and RAID Support** section.

---

### CAUTION!

- Do not unplug portable disk, power system, press the Clear CMOS button, or short the CLRTC header while BIOS update is ongoing, otherwise update will be interrupted. In case of interruption, please follow the steps again.
  - If the light flashes for five seconds and turns into a solid light, this means that the BIOS FlashBack™ is not operating properly. This may be caused by improper installation of the USB storage device and filename/file format error. If this scenario happens, please restart the system to turn off the light.
  - Updating BIOS may have risks. If the BIOS program is damaged during the process and results to the system's failure to boot up, please contact your local ASUS Service Center.
-

## 2.7 Starting up for the first time

1. After making all the connections, replace the system case cover.
2. Ensure that all switches are off.
3. Connect the power cord to the power connector at the back of the system chassis.
4. Connect the power cord to a power outlet that is equipped with a surge protector.
5. Turn on the devices in the following order:
  - a. Monitor
  - b. External storage devices (starting with the last device on the chain)
  - c. System power
6. After applying power, the system power LED on the system front panel case lights up. For systems with ATX power supplies, the system LED lights up when you press the ATX power button. If your monitor complies with the “green” standards or if it has a “power standby” feature, the monitor LED may light up or change from orange to green after the system LED turns on.

The system then runs the power-on self tests (POST). While the tests are running, additional messages appear on the screen. If you do not see anything within 30 seconds from the time you turned on the power, the system may have failed a power-on test. Check the jumper settings and connections or call your retailer for assistance.
7. At power on, hold down the <Delete> key to enter the BIOS Setup. Follow the instructions in Chapter 3.

## 2.8 Turning off the computer

While the system is ON, press the power button for less than four seconds to put the system on sleep mode or soft-off mode, depending on the BIOS setting. Press the power button for more than four seconds to let the system enter the soft-off mode regardless of the BIOS setting.

# BIOS and RAID Support

---

**NOTE:** For more details on BIOS and RAID configurations, please refer to Manual & Document under the Support tab of the product information site, or visit <https://www.asus.com/support>.

---

## 3.1 Knowing UEFI BIOS

BIOS (Basic Input and Output System) stores system hardware settings such as storage device configuration, overclocking settings, advanced power management, and boot device configuration that are needed for system startup in the motherboard CMOS. In normal circumstances, the default BIOS settings apply to most conditions to ensure optimal performance. **DO NOT change the default BIOS settings** except in the following circumstances:

- An error message appears on the screen during the system bootup and requests you to run the BIOS Setup.
- You have installed a new system component that requires further BIOS settings or update.

---

**CAUTION!** Inappropriate BIOS settings may result to instability or boot failure. **We strongly recommend that you change the BIOS settings only with the help of a trained service personnel.**

---

---

**NOTE:** BIOS settings and options may vary due to different BIOS release versions. Please refer to the latest BIOS version for settings and options.

---

### Entering BIOS at startup

To enter BIOS Setup at startup, press <Delete> or <F2> during the Power-On Self Test (POST). If you do not press <Delete> or <F2>, POST continues with its routines.

---

#### **IMPORTANT!**

- If the system becomes unstable after changing any BIOS setting, load the default settings to ensure system compatibility and stability. Select the **Load Optimized Defaults** item under the **Exit** menu or press the <F5> hotkey.
  - If the system fails to boot after changing any BIOS setting, try to clear the CMOS and reset the motherboard to the default value.
  - The BIOS setup program does not support Bluetooth devices.
- 

### BIOS menu screen

The BIOS Setup program can be used under two modes: **EZ Mode** and **Advanced Mode**. You can change modes from **Setup Mode** in **Boot menu** or by pressing the <F7> hotkey.

## 3.2 ASUS EZ Flash 3

The ASUS EZ Flash 3 feature allows you to update the BIOS without using an OS-based utility.

---

**IMPORTANT!** Ensure to load the BIOS default settings to ensure system compatibility and stability. Select the **Load Optimized Defaults** item under the **Exit** menu or press the <F5> hotkey.

---

### To update the BIOS:

---

**CAUTION!**

- This function can support devices such as a USB flash disk with FAT 32/16 format and single partition only.
  - DO NOT shut down or reset the system while updating the BIOS to prevent system boot failure!
- 

1. Insert the USB flash disk that contains the latest BIOS file to the USB port.
2. Enter the Advanced Mode of the BIOS setup program. Go to the **Tool** menu to select **ASUS EZ Flash 3 Utility** and press <Enter>.
3. Press the Left arrow key to switch to the **Drive** field.
4. Press the Up/Down arrow keys to find the USB flash disk that contains the latest BIOS, and then press <Enter>.
5. Press the Right arrow key to switch to the **Folder** field.
6. Press the Up/Down arrow keys to find the BIOS file, and then press <Enter> to perform the BIOS update process. Reboot the system when the update process is done.



### 3.3 ASUS CrashFree BIOS 3

The ASUS CrashFree BIOS 3 utility is an auto recovery tool that allows you to restore the BIOS file when it fails or gets corrupted during the updating process. You can restore a corrupted BIOS file using a USB flash drive that contains the BIOS file.

#### Recovering the BIOS

1. Download the latest BIOS version for this motherboard from <https://www.asus.com/support/>.
2. Rename the file using one of the following methods:
  - Launch the **BIOSRenamer.exe** application to automatically rename the file.
  - Manually rename the file to the BIOS CAP filename specified in the **Specifications summary** section.
  - Manually rename the file to **ASUS.CAP**.
3. Copy the renamed file to your USB storage device.
4. Turn on the system.
5. Insert the USB flash drive containing the BIOS file to a USB port.
6. The utility automatically checks the devices for the BIOS file. When found, the utility reads the BIOS file and enters ASUS EZ Flash 3 automatically.
7. The system requires you to enter BIOS Setup to recover the BIOS setting. To ensure system compatibility and stability, we recommend that you press the <F5> hotkey to load default BIOS values.

---

**CAUTION!** DO NOT shut down or reset the system while updating the BIOS! Doing so may cause system boot failure!

---

## 3.4 RAID configurations

The motherboard supports RAID configurations.

### RAID definitions

**Volume** provides the ability to link-together storage from one or several disks, regardless of the size of the space on those disks. This configuration is useful in scavenging space on disks unused by other disks in the array. This configuration does not provide performance benefits or data redundancy, disk failure will result in data loss.

**RAIDABLE** arrays (also known as RAID Ready) are a special type of Volume (JBOD) that allows the user to add more storage space or create a redundant array after a system is installed.

---

**NOTE:** The ability to create RAIDABLE arrays may vary per system.

---

**RAID 0 (Data striping)** optimizes two identical hard disk drives to read and write data in parallel, interleaved stacks. Two hard disks perform the same work as a single drive but at a sustained data transfer rate, double that of a single disk alone, thus improving data access and storage. Use of two new identical hard disk drives is required for this setup.

**RAID 1 (Data mirroring)** copies and maintains an identical image of data from one drive to a second drive. If one drive fails, the disk array management software directs all applications to the surviving drive as it contains a complete copy of the data in the other drive. This RAID configuration provides data protection and increases fault tolerance to the entire system. Use two new drives or use an existing drive and a new drive for this setup. The new drive must be of the same size or larger than the existing drive.

**RAID 5** stripes both data and parity information across three or more hard disk drives. Among the advantages of RAID 5 configuration include better HDD performance, fault tolerance, and higher storage capacity. The RAID 5 configuration is best suited for transaction processing, relational database applications, enterprise resource planning, and other business systems. Use a minimum of three identical hard disk drives for this setup.

**RAID 10** is data striping and data mirroring combined without parity (redundancy data) having to be calculated and written. With the RAID 10 configuration you get all the benefits of both RAID 0 and RAID 1 configurations. Use four new hard disk drives or use an existing drive and three new drives for this setup.

# Appendix

## Q-Code table

Code	Description
00	Not used
01	Power on. Reset type detection (soft/hard).
02	AP initialization before microcode loading
03	System Agent initialization before microcode loading
04	PCH initialization before microcode loading
06	Microcode loading
07	AP initialization after microcode loading
08	System Agent initialization after microcode loading
09	PCH initialization after microcode loading
0B	Cache initialization
0C – 0D	Reserved for future AMI SEC error codes
0E	Microcode not found
0F	Microcode not loaded
10	PEI Core is started
11 – 14	Pre-memory CPU initialization is started
15 – 18	Pre-memory System Agent initialization is started
19 – 1C	Pre-memory PCH initialization is started
2B – 2F	Memory initialization
30	Reserved for ASL (see ASL Status Codes section below)
31	Memory Installed
32 – 36	CPU post-memory initialization
37 – 3A	Post-Memory System Agent initialization is started
3B – 3E	Post-Memory PCH initialization is started
4F	DXE IPL is started
50 – 53	Memory initialization error. Invalid memory type or incompatible memory speed
54	Unspecified memory initialization error
55	Memory not installed
56	Invalid CPU type or Speed
57	CPU mismatch
58	CPU self test failed or possible CPU cache error
59	CPU micro-code is not found or micro-code update is failed
5A	Internal CPU error
5B	Reset PPI is not available
5C – 5F	Reserved for future AMI error codes

*(continued on the next page)*

## Q-Code table

Code	Description
E0	S3 Resume is started (S3 Resume PPI is called by the DXE IPL)
E1	S3 Boot Script execution
E2	Video repost
E3	OS S3 wake vector call
E4 – E7	Reserved for future AMI progress codes
E8	S3 Resume Failed
E9	S3 Resume PPI not Found
EA	S3 Resume Boot Script Error
EB	S3 OS Wake Error
EC – EF	Reserved for future AMI error codes
F0	Recovery condition triggered by firmware (Auto recovery)
F1	Recovery condition triggered by user (Forced recovery)
F2	Recovery process started
F3	Recovery firmware image is found
F4	Recovery firmware image is loaded
F5 – F7	Reserved for future AMI progress codes
F8	Recovery PPI is not available
F9	Recovery capsule is not found
FA	Invalid recovery capsule
FB – FF	Reserved for future AMI error codes
60	DXE Core is started
61	NVRAM initialization
62	Installation of the PCH Runtime Services
63 – 67	CPU DXE initialization is started
68	PCI host bridge initialization
69	System Agent DXE initialization is started
6A	System Agent DXE SMM initialization is started
6B – 6F	System Agent DXE initialization (System Agent module specific)
70	PCH DXE initialization is started
71	PCH DXE SMM initialization is started
72	PCH devices initialization
73 – 77	PCH DXE Initialization (PCH module specific)
78	ACPI module initialization
79	CSM initialization
7A – 7F	Reserved for future AMI DXE codes

*(continued on the next page)*

## Q-Code table

Code	Description
90	Boot Device Selection (BDS) phase is started
91	Driver connecting is started
92	PCI Bus initialization is started
93	PCI Bus Hot Plug Controller Initialization
94	PCI Bus Enumeration
95	PCI Bus Request Resources
96	PCI Bus Assign Resources
97	Console Output devices connect
98	Console input devices connect
99	Super IO Initialization
9A	USB initialization is started
9B	USB Reset
9C	USB Detect
9D	USB Enable
9E – 9F	Reserved for future AMI codes
A0	IDE initialization is started
A1	IDE Reset
A2	IDE Detect
A3	IDE Enable
A4	SCSI initialization is started
A5	SCSI Reset
A6	SCSI Detect
A7	SCSI Enable
A8	Setup Verifying Password
A9	Start of Setup
AA	Reserved for ASL (see ASL Status Codes section below)
AB	Setup Input Wait
AC	Reserved for ASL (see ASL Status Codes section below)
AD	Ready To Boot event
AE	Legacy Boot event
AF	Exit Boot Services event
B0	Runtime Set Virtual Address MAP Begin
B1	Runtime Set Virtual Address MAP End
B2	Legacy Option ROM Initialization
B3	System Reset

*(continued on the next page)*

## Q-Code table

Code	Description
B4	USB hot plug
B5	PCI bus hot plug
B6	Clean-up of NVRAM
B7	Configuration Reset (reset of NVRAM settings)
B8– BF	Reserved for future AMI codes
D0	CPU initialization error
D1	System Agent initialization error
D2	PCH initialization error
D3	Some of the Architectural Protocols are not available
D4	PCI resource allocation error. Out of Resources
D5	No Space for Legacy Option ROM
D6	No Console Output Devices are found
D7	No Console Input Devices are found
D8	Invalid password
D9	Error loading Boot Option (LoadImage returned error)
DA	Boot Option is failed (StartImage returned error)
DB	Flash update is failed
DC	Reset protocol is not available

### ACPI/ASL Checkpoints (under OS)

Code	Description
03	System is entering S3 sleep state
04	System is entering S4 sleep state
05	System is entering S5 sleep state
30	System is waking up from the S3 sleep state
40	System is waking up from the S4 sleep state
AC	System has transitioned into ACPI mode. Interrupt controller is in PIC mode.
AA	System has transitioned into ACPI mode. Interrupt controller is in APIC mode.

## General notices

### FCC Compliance Information

Responsible Party: Asus Computer International

Address: 48720 Kato Rd., Fremont, CA 94538, USA

Phone / Fax No: (510)739-3777 / (510)608-4555

This device complies with part 15 of the FCC Rules. Operation is subject to the following two conditions: (1) This device may not cause harmful interference, and (2) this device must accept any interference received, including interference that may cause undesired operation.

This equipment has been tested and found to comply with the limits for a Class B digital device, pursuant to part 15 of the FCC Rules. These limits are designed to provide reasonable protection against harmful interference in a residential installation. This equipment generates, uses and can radiate radio frequency energy and, if not installed and used in accordance with the instructions, may cause harmful interference to radio communications. However, there is no guarantee that interference will not occur in a particular installation. If this equipment does cause harmful interference to radio or television reception, which can be determined by turning the equipment off and on, the user is encouraged to try to correct the interference by one or more of the following measures:

- Reorient or relocate the receiving antenna.
- Increase the separation between the equipment and receiver.
- Connect the equipment into an outlet on a circuit different from that to which the receiver is connected.
- Consult the dealer or an experienced radio/TV technician for help.

### HDMI Trademark Notice

The terms HDMI, HDMI High-Definition Multimedia Interface, HDMI trade dress and the HDMI Logos are trademarks or registered trademarks of HDMI Licensing Administrator, Inc.



### 安全上のご注意

付属品は当該専用品です。他の機器には使用しないでください。機器の破損もしくは、火災や感電の原因となることがあります。

# VCCI: Japan Compliance Statement

## Class B ITE

この装置は、クラスB情報技術装置です。この装置は、家庭環境で使用することを目的としていますが、この装置がラジオやテレビジョン受信機に近接して使用されると、受信障害を引き起こすことがあります。

取扱説明書に従って正しい取り扱いをして下さい。

V C C I - B

## Japan JATE

本製品は電気通信事業者（移动通信会社、固定通信会社、インターネットプロバイダ等）の通信回線（公衆無線LANを含む）に直接接続することができません。本製品をインターネットに接続する場合は、必ずルーター等を経由し接続してください。

## Australia statement notice

From 1 January 2012 updated warranties apply to all ASUS products, consistent with the Australian Consumer Law. For the latest product warranty details please visit <https://www.asus.com/support/>. Our goods come with guarantees that cannot be excluded under the Australian Consumer Law. You are entitled to a replacement or refund for a major failure and compensation for any other reasonably foreseeable loss or damage. You are also entitled to have the goods repaired or replaced if the goods fail to be of acceptable quality and the failure does not amount to a major failure.

If you require assistance please call ASUS Customer Service 1300 2787 88 or visit us at <https://www.asus.com/support/>.

## Declaration of compliance for product environmental regulation

ASUS follows the green design concept to design and manufacture our products, and makes sure that each stage of the product life cycle of ASUS product is in line with global environmental regulations. In addition, ASUS disclose the relevant information based on regulation requirements.

Please refer to <https://esg.asus.com/Compliance.htm> for information disclosure based on regulation requirements ASUS is complied with:

### EU REACH and Article 33

Complying with the REACH (Registration, Evaluation, Authorisation, and Restriction of Chemicals) regulatory framework, we published the chemical substances in our products at ASUS REACH website at <https://esg.asus.com/Compliance.htm>.

### EU RoHS

This product complies with the EU RoHS Directive. For more details, see <https://esg.asus.com/Compliance.htm>



## India RoHS

This product complies with the "India E-Waste (Management) Rules, 2016" and prohibits use of lead, mercury, hexavalent chromium, polybrominated biphenyls (PBBs) and polybrominated diphenyl ethers (PBDEs) in concentrations exceeding 0.1% by weight in homogenous materials and 0.01% by weight in homogenous materials for cadmium, except for the exemptions listed in Schedule II of the Rule.

## Vietnam RoHS

ASUS products sold in Vietnam, on or after September 23, 2011, meet the requirements of the Vietnam Circular 30/2011/TT-BCT.

Các sản phẩm ASUS bán tại Việt Nam, vào ngày 23 tháng 9 năm 2011 trở về sau, đều phải đáp ứng các yêu cầu của Thông tư 30/2011/TT-BCT của Việt Nam.

## Türkiye RoHS

AEEE Yönetmeliğine Uygundur

## ASUS Recycling/Takeback Services

ASUS recycling and takeback programs come from our commitment to the highest standards for protecting our environment. We believe in providing solutions for you to be able to responsibly recycle our products, batteries, other components as well as the packaging materials. Please go to <https://esg.asus.com/en/Takeback.htm> for detailed recycling information in different regions.



DO NOT throw the motherboard in municipal waste. This product has been designed to enable proper reuse of parts and recycling. This symbol of the crossed out wheeled bin indicates that the product (electrical and electronic equipment) should not be placed in municipal waste. Check local regulations for disposal of electronic products.



DO NOT throw the mercury-containing button cell battery in municipal waste. This symbol of the crossed out wheeled bin indicates that the battery should not be placed in municipal waste.

## France sorting and recycling information



Points de collecte sur [www.quefairemesdechets.fr](http://www.quefairemesdechets.fr)  
Privilégiez la réparation ou le don de votre appareil !

## **Notices for Wi-Fi model**

### **FCC RF Caution Statement**

**WARNING:** Any changes or modifications not expressly approved by the party responsible for compliance could void your authority to operate the equipment.

### **FCC Wi-Fi Caution Statement**

Operation of transmitters in the 5.925-7.125 GHz band is prohibited for control of or communications with unmanned aircraft systems.

### **RF exposure warning**

This equipment must be installed and operated in accordance with provided instructions and the antenna(s) used for this transmitter must be installed to provide a separation distance of at least 20 cm from all persons and must not be co-located or operating in conjunction with any other antenna or transmitter. End-users and installers must be provided with antenna installation instructions and transmitter operating conditions for satisfying RF exposure compliance.

### **Compliance Statement of Innovation, Science and Economic Development Canada (ISED)**

This device complies with Innovation, Science and Economic Development Canada licence exempt RSS standard(s). Operation is subject to the following two conditions: (1) this device may not cause interference, and (2) this device must accept any interference, including interference that may cause undesired operation of the device.

Operation in the band 5150–5250 MHz is only for indoor use to reduce the potential for harmful interference to co-channel mobile satellite systems.

CAN ICES-003(B)/NMB-003(B)

### **Déclaration de conformité de Innovation, Sciences et Développement économique Canada (ISED)**

Le présent appareil est conforme aux CNR d'Innovation, Sciences et Développement économique Canada applicables aux appareils radio exempts de licence. L'exploitation est autorisée aux deux conditions suivantes : (1) l'appareil ne doit pas produire de brouillage, et (2) l'utilisateur de l'appareil doit accepter tout brouillage radioélectrique subi, même si le brouillage est susceptible d'en compromettre le fonctionnement.

La bande 5150–5250 MHz est réservée uniquement pour une utilisation à l'intérieur afin de réduire les risques de brouillage préjudiciable aux systèmes de satellites mobiles utilisant les mêmes canaux.

CAN ICES-003(B)/NMB-003(B)

### **ISED Wi-Fi Caution Statement (RLAN devices)**

Devices shall not be used for control of or communications with unmanned aircraft systems.

Les dispositifs ne doivent pas être utilisés pour commander des systèmes d'aéronef sans pilote ni pour communiquer avec de tels systèmes.

## KC: Korea Warning Statement

B급 기기 (가정용 방송통신기자재)

이 기기는 가정용(B급) 전자파적합기기로서 주로 가정에서 사용하는 것을 목적으로 하며, 모든 지역에서 사용할 수 있습니다.

\*당해 무선설비는 전파혼신 가능성이 있으므로 인명안전과 관련된 서비스는 할 수 없습니다.

## NCC: Wireless Statement

取得審驗證明之低功率射頻器材，非經核准，公司、商號或使用者均不得擅自變更頻率、加大功率或變更原設計之特性及功能。低功率射頻器材之使用不得影響飛航安全及干擾合法通信；經發現有干擾現象時，應立即停用，並改善至無干擾時方得繼續使用。前述合法通信，指依電信管理法規定作業之無線電通信。低功率射頻器材須忍受合法通信或工業、科學及醫療用電波輻射性電機設備之干擾。

應避免影響附近雷達系統之操作。

## Japan RF Equipment Statement

### 屋外での使用について

本製品は、5GHz帯域での通信に対応しています。電波法の定めにより5.2GHz、5.3GHz、及び6GHz帯域の電波は屋外で使用が禁じられています。

### 法律および規制遵守

本製品は電波法及びこれに基づく命令の定めるところに従い使用してください。日本国外では、その国の法律または規制により、本製品の使用ができないことがあります。このような国では、本製品を運用した結果、罰せられることがあります。当社は一切責任を負いかねますのでご了承ください。

## Précautions d'emploi de l'appareil :

- Soyez particulièrement vigilant quant à votre sécurité lors de l'utilisation de cet appareil dans certains lieux (les avions, les aéroports, les hôpitaux, les stations-service et les garages professionnels).
- Évitez d'utiliser cet appareil à proximité de dispositifs médicaux implantés. Si vous portez un implant électronique (stimulateurs cardiaques, pompes à insuline, neurostimulateurs...), veuillez impérativement respecter une distance minimale de 15 centimètres entre cet appareil et l'implant pour réduire les risques d'interférence.
- Utilisez cet appareil dans de bonnes conditions de réception pour minimiser le niveau de rayonnement. Ce n'est pas toujours le cas dans certaines zones ou situations, notamment dans les parkings souterrains, dans les ascenseurs, en train ou en voiture ou tout simplement dans un secteur mal couvert par le réseau.
- Tenez cet appareil à distance du ventre des femmes enceintes et du bas-ventre des adolescents.



## Simplified EU Declaration of Conformity

ASUSTek Computer Inc. hereby declares that this device is in compliance with the essential requirements and other relevant provisions of Directive 2014/53/EU. Full text of EU declaration of conformity is available at <https://www.asus.com/support/>.

The WiFi operating in the band 5150-5350 MHz shall be restricted to indoor use for countries listed in the table below:

- a. Low Power Indoor (LPI) Wi-Fi 5.945-6.425 GHz devices:  
The device is restricted to indoor use only when operating in the 5945 to 6425 MHz frequency range in Austria (AT), Belgium (BE), Bulgaria (BG), Cyprus (CY), Czech Republic (CZ), Estonia (EE), France (FR), Germany (DE), Iceland (IS), Ireland (IE), Latvia (LV), Luxembourg (LU), Netherlands (NL), Norway (NO), Romania (RO), Slovakia (SK), Slovenia (SI), Spain (ES), Switzerland (CH)
- b. Very Low Power (VLP) Wi-Fi 5.945-6.425 GHz devices (portable devices):  
The device is not permitted to be used on Unmanned Aircraft Systems (UAS) when operating in the 5945 to 6425 MHz frequency range in Austria (AT), Belgium (BE), Bulgaria (BG), Cyprus (CY), Czech Republic (CZ), Estonia (EE), France (FR), Germany (DE), Iceland (IS), Ireland (IE), Latvia (LV), Luxembourg (LU), Netherlands (NL), Norway (NO), Romania (RO), Slovakia (SK), Slovenia (SI), Spain (ES), Switzerland (CH)

## Déclaration de conformité simplifiée de l'UE

ASUSTek COMPUTER INC. déclare par la présente que cet appareil est conforme aux critères essentiels et autres clauses pertinentes de la directive 2014/53/UE. La déclaration de conformité de l'UE peut être téléchargée à partir du site internet suivant : <https://www.asus.com/fr/support/>.

Dans la plage de fréquences 5150-5350 MHz, le WiFi est restreint à une utilisation en intérieur dans les pays listés ci-dessous :

- a. Pour les appareils WiFi LPI (Low Power Indoor) dans la plage 5,945-6,425 GHz :  
L'appareil est limité à une utilisation en intérieur uniquement lorsqu'il fonctionne dans la plage de fréquences 5945-6425 MHz en Autriche (AT), Belgique (BE), Bulgarie (BG), Chypre (CY), République tchèque (CZ), Estonie (EE), France (FR), Allemagne (DE), Islande (IS), Irlande (IE), Lettonie (LV), Luxembourg (LU), Pays-Bas (NL), Norvège (NO), Roumanie (RO), Slovaquie (SK), Slovaquie (SI), Espagne (ES), Suisse (CH).
- b. Pour les appareils portables WiFi VLP (Very Low Power) dans la plage 5,945-6,425 GHz :  
L'appareil n'est pas autorisé à être utilisé sur des systèmes d'aéronefs sans pilote (UAS) lorsqu'il fonctionne dans la plage de fréquences 5945-6425 MHz en en Autriche (AT), Belgique (BE), Bulgarie (BG), Chypre (CY), République tchèque (CZ), Estonie (EE), France (FR), Allemagne (DE), Islande (IS), Irlande (IE), Lettonie (LV), Luxembourg (LU), Pays-Bas (NL), Norvège (NO), Roumanie (RO), Slovaquie (SK), Slovaquie (SI), Espagne (ES), Suisse (CH).

## Vereinfachte EU-Konformitätserklärung

ASUSTek Computer Inc. erklärt hiermit, dass dieses Gerät mit den wesentlichen Anforderungen und anderen relevanten Bestimmungen der Richtlinie 2014/53/EU übereinstimmt. Der gesamte Text der EU-Konformitätserklärung ist verfügbar unter: <https://www.asus.com/support/>.

Der WLAN-Betrieb im Band von 5150-5350 MHz ist für die in der unteren Tabelle aufgeführten Länder auf den Innenbereich beschränkt:

- a. Low Power Indoor (LPI) Wi-Fi 5,945 bis 6,425 GHz-Geräte:  
Das Gerät ist auf den Innenbereich beschränkt, wenn es im Frequenzbereich von 5945 MHz bis 6425 MHz in Österreich (AT), Belgien (BE), Bulgarien (BG), Zypern (CY), der Tschechischen Republik (CZ), Estland (EE), Frankreich (FR), Deutschland (DE), Island (IS), Irland (IE), Lettland (LV), Luxemburg (LU), den Niederlanden (NL), Norwegen (NO), Rumänien (RO), der Slowakei (SK), Slowenien (SI), Spanien (ES) und der Schweiz (CH) betrieben wird.
- b. Very Low Power (VLP) Wi-Fi 5,945 bis 6,425 GHz-Geräte (tragbare Geräte):  
Das Gerät darf nicht auf unbemannten Luftfahrzeugsystemen (UAS) verwendet werden, wenn es im Frequenzbereich von 5945 MHz bis 6425 MHz in Österreich (AT), Belgien (BE), Bulgarien (BG), Zypern (CY), der Tschechischen Republik (CZ), Estland (EE), Frankreich (FR), Deutschland (DE), Island (IS), Irland (IE), Lettland (LV), Luxemburg (LU), den Niederlanden (NL), Norwegen (NO), Rumänien (RO), der Slowakei (SK), Slowenien (SI), Spanien (ES) und der Schweiz (CH) betrieben wird.

## Dichiarazione di conformità UE semplificata

ASUSTek Computer Inc. con la presente dichiara che questo dispositivo è conforme ai requisiti essenziali e alle altre disposizioni pertinenti con la direttiva 2014/53/UE. Il testo completo della dichiarazione di conformità UE è disponibile all'indirizzo: <https://www.asus.com/support/>.

L'utilizzo della rete Wi-Fi con frequenza compresa nell'intervallo 5150-5350MHz deve essere limitato all'interno degli edifici per i paesi presenti nella seguente tabella:

- a. Dispositivi LPI (Low Power Indoor) Wi-Fi 5.945-6.425 GHz:  
Il dispositivo è limitato all'uso in ambienti interni quando funziona nella gamma di frequenza da 5945 a 6425 MHz in Austria (AT), Belgio (BE), Bulgaria (BG), Cipro (CY), Repubblica Ceca (CZ), Estonia (EE), Francia (FR), Germania (DE), Islanda (IS), Irlanda (IE), Lettonia (LV), Lussemburgo (LU), Paesi Bassi (NL), Norvegia (NO), Romania (RO), Slovacchia (SK), Slovenia (SI), Spagna (ES), Svizzera (CH).
- b. Dispositivi VLP (Very Low Power) Wi-Fi 5.945-6.425 GHz (dispositivi portatili):  
Il dispositivo non può essere utilizzato su Unmanned Aircraft Systems (UAS) quando opera nella gamma di frequenza da 5945 a 6425 MHz in Austria (AT), Belgio (BE), Bulgaria (BG), Cipro (CY), Repubblica Ceca (CZ), Estonia (EE), Francia (FR), Germania (DE), Islanda (IS), Irlanda (IE), Lettonia (LV), Lussemburgo (LU), Paesi Bassi (NL), Norvegia (NO), Romania (RO), Slovacchia (SK), Slovenia (SI), Spagna (ES), Svizzera (CH).

## Издание соответствует основным требованиям директив ЕС

Настоящим, ASUSTek COMPUTER INC., заявляет, что устройство соответствует основным требованиям и другим соответствующим условиям директивы 2014/53/ЕУ. Полный текст декларации соответствия ЕС доступен на <https://www.asus.com/ru/support/>.

Работа WiFi в диапазоне частот 5150-5350 должна быть ограничена использованием в помещениях для стран, перечисленных в таблице ниже:

- a. Устройства Wi-Fi 5,945–6,425 ГГц для помещений с низким энергопотреблением (LPI): Устройство предназначено для использования внутри помещений только при работе в диапазоне частот от 5945 до 6425 МГц в Австрии (АТ), Бельгии (BE), Болгарии (BG), Кипре (CY), Чехии (CZ), Эстонии (EE), Франции (FR), Германии (DE), Исландии (IS), Ирландии (IE), Латвии (LV), Люксембурге (LU), Нидерландах (NL), Норвегии (NO), Румынии (RO), Словакии (SK), Словении (SI), Испании (ES), Швейцарии (CH)
- b. Устройства Wi-Fi с очень низким энергопотреблением (VLP) 5,945–6,425 ГГц (портативные устройства): Устройство не разрешается использовать в беспилотных авиационных системах (БАС) при работе в диапазоне частот от 5945 до 6425 МГц в Австрии (АТ), Бельгии (BE), Болгарии (BG), Кипре (CY), Чехии (CZ), Эстонии (EE), Франции (FR), Германии (DE), Исландии (IS), Ирландии (IE), Латвии (LV), Люксембурге (LU), Нидерландах (NL), Норвегии (NO), Румынии (RO), Словакии (SK), Словении (SI), Испании (ES), Швейцарии (CH)

## Опростена декларация за съответствие на ЕС

С настоящото ASUSTek Computer Inc. декларира, че това устройство е в съответствие със съществени изисквания и другите приложими постановления на свързаната Директива 2014/53/ЕУ. Пълният текст на ЕС декларация за съвместимост е достъпен на адрес <https://www.asus.com/support/>.

WiFi, работеща в диапазон 5150-5350MHz, трябва да се ограничи до употреба на закрито за страните, посочени в таблицата по-долу:

- a. Ниско захранване на закрито (LPI) Wi-Fi 5,945-6,425 GHz устройства:  
Устройството е ограничено до употреба само на закрито, когато работи в честотния диапазон от 5945 до 6425 в Австрия (АТ), Белгия (BE), България (BG), Кипър (CY), Чехия (CZ), Естония (EE), Франция (FR), Германия (DE), Исландия (IS), Ирландия (IE), Латвия (LV), Люксембург (LU), Нидерландия (NL), Норвегия (NO), Румъния (RO), Словакия (SK), Словения (SI), Испания (ES), Швейцария (CH).
- b. Много ниско захранване (VLP) Wi-Fi 5,945-6,425 GHz устройство (преносими устройства):  
Устройството не е разрешено за употреба в беспилотни летателни средства (UAS) при работа в честотния диапазон от 5945 до 6425 MHz в Австрия (АТ), Белгия (BE), България (BG), Кипър (CY), Чехия (CZ), Естония (EE), Франция (FR), Германия (DE), Исландия (IS), Ирландия (IE), Латвия (LV), Люксембург (LU), Нидерландия (NL), Норвегия (NO), Румъния (RO), Словакия (SK), Словения (SI), Испания (ES), Швейцария (CH).

## Pojednostavljena EU Izjava o sukladnosti

ASUSTek Computer Inc. ovim izjavi tvrdi da je ovaj uređaj sukladan s bitnim zahtjevima i ostalim odgovarajućim odredbama direktive 2014/53/EU. Cijeli tekst EU izjave o sukladnosti dostupan je na <https://www.asus.com/support/>.

WiFi koji radi na opsegu frekvencija 5150-5350 MHz bit će ograničen na upotrebu u zatvorenom prostoru u zemljama na donjem popisu:

- Unutarnji uređaji male snage (LPI) Wi-Fi 5,945 – 6,425 GHz: Uređaj je ograničen na upotrebu u zatvorenom prostoru samo kada radi u frekvencijskom pojasu od 5945 do 6425 MHz u Austriji (AT), Belgiji (BE), Bugarskoj (BG), Cipru (CY), Češkoj (CZ), Estoniji (EE), Francuskoj (FR), Njemačkoj (DE), Islandu (IS), Irskoj (IE), Latviji (LV), Luksemburgu (LU), Nizozemskoj (NL), Norveškoj (NO), Rumunjskoj (RO), Slovačkoj (SK), Sloveniji (SI), Španjolskoj (ES), Švicarskoj (CH).
- Uređaji vrlo male snage (VLP) Wi-Fi 5,945 – 6,425 GHz (prijenosni uređaji): Uređaj nije dopušteno koristiti u sustavima bespilotnih letjelica (UAS) kada radi u frekvencijskom pojasu od 5945 do 6425 MHz u Austriji (AT), Belgiji (BE), Bugarskoj (BG), Cipru (CY), Češkoj (CZ), Estoniji (EE), Francuskoj (FR), Njemačkoj (DE), Islandu (IS), Irskoj (IE), Latviji (LV), Luksemburgu (LU), Nizozemskoj (NL), Norveškoj (NO), Rumunjskoj (RO), Slovačkoj (SK), Sloveniji (SI), Španjolskoj (ES), Švicarskoj (CH).

## Zjednodušené prohlášení o shodě EU

Společnost ASUSTek Computer Inc. tímto prohlašuje, že toto zařízení splňuje základní požadavky a další příslušná ustanovení směrnice 2014/53/EU. Plné znění prohlášení o shodě EU je k dispozici na adrese <https://www.asus.com/support/>.

V zemích uvedených v tabulce je provoz síť Wi-Fi ve frekvenčním rozsahu 5 150 - 5 350 MHz povolen pouze ve vnitřních prostorech:

- Zařízení Wi-Fi s nízkým výkonem („LPI“) pro pásmo 5,945 – 6,425 GHz: Při provozu ve frekvenčním pásmu 5945 až 6425 MHz je používání tohoto zařízení omezeno pouze na interiéry v Rakousku (AT), Belgii (BE), Bulharsku (BG), Kypru (CY), České republice (CZ), Estonsku (EE), Francii (FR), Německu (DE), Islandu (IS), Irsku (IE), Lotyšsku (LV), Lucembursku (LU), Nizozemsku (NL), Norsku (NO), Rumunsku (RO), Slovensku (SK), Slovinsku (SI), Španělsku (ES), Švýcarsku (CH).
- Zařízení Wi-Fi s velmi nízkým výkonem („VLP“) pro pásmo 5,945 – 6,425 GHz (přenosná zařízení): Při provozu ve frekvenčním pásmu 5945 až 6425 MHz není povoleno používat toto zařízení v systémech bezpilotních letadel (UAS) v Rakousku (AT), Belgii (BE), Bulharsku (BG), Kypru (CY), České republice (CZ), Estonsku (EE), Francii (FR), Německu (DE), Islandu (IS), Irsku (IE), Lotyšsku (LV), Lucembursku (LU), Nizozemsku (NL), Norsku (NO), Rumunsku (RO), Slovensku (SK), Slovinsku (SI), Španělsku (ES), Švýcarsku (CH).

## Forenklet EU-overensstemmelseserklæring

ASUSTek Computer Inc. erklærer hermed at denne enhed er i overensstemmelse med hovedkravene og øvrige relevante bestemmelser i direktivet 2014/53/EU. Hele EU-overensstemmelseserklæringen kan findes på <https://www.asus.com/support/>.

Wi-Fi, der bruger 5150-5350 MHz skal begrænses til indendørs brug i lande, der er anført i tabellen:

- Lav effekt indendørs (LPI) Wi-Fi 5.945-6.425 GHz-enheder: Enheden må kun bruges indendørs, når den bruges inden for frekvensområdet 5945 til 6425 MHz i Østrig (AT), Belgien (BE), Bulgarien (BG), Cypern (CY), Tjekkiet (CZ), Estland (EE), Frankrig (FR), Tyskland (DE), Island (IS), Irland (IE), Letland (LV), Luxembourg (LU), Holland (NL), Norge (NO), Rumænien (RO), Slovakiet (SK), Slovenien (SI), Spanien (ES), Schweiz (CH).
- Meget lav strøm indendørs (VLP) Wi-Fi 5.945-6.425 GHz-enheder (bærbare enheder): Enheden må kun bruges i ubemandede flysystemer (UAS), når den bruges inden for frekvensområdet 5945 til 6425 MHz i Østrig (AT), Belgien (BE), Bulgarien (BG), Cypern (CY), Tjekkiet (CZ), Estland (EE), Frankrig (FR), Tyskland (DE), Island (IS), Irland (IE), Letland (LV), Luxembourg (LU), Holland (NL), Norge (NO), Rumænien (RO), Slovakiet (SK), Slovenien (SI), Spanien (ES), Schweiz (CH).

## Vereenvoudigd EU-conformiteitsverklaring

ASUSTek Computer Inc. verklaart hierbij dat dit apparaat voldoet aan de essentiële vereisten en andere relevante bepalingen van Richtlijn 2014/53/EU. De volledige tekst van de EU-conformiteitsverklaring is beschikbaar op <https://www.asus.com/support/>.

De WiFi op 5150-5350MHz zal beperkt zijn tot binnengebruik voor in de tabel vermelde landen:

- LPI (Low Power Indoor-laag vermogen binnenshuis) Wi-Fi 5.945-6.425 GHz-apparaten: Het apparaat is beperkt tot enkel binnengebruik bij bedieners in het frequentiebereik van 5945 tot 6425 MHz in Oostenrijk (AT), België (BE), Bulgarije (BG), Cyprus (CY), Tsjechose Republiek (CZ), Estland (EE), Frankrijk (FR), Duitsland (NL), Island (IS), Ierland (IE), Letland (LV), Luxemburg (LU), Nederland (NL), Noorwegen (NO), Roemenië (RO), Slowakije (SK), Slovenië (SI), Spanje (ES), Zwitserland (CH).
- VLP (Very Low Power = zeer laag vermogen) Wi-Fi 5.945-6.425 GHz-apparaten (draagbare apparaten): Het apparaat mag niet worden gebruikt in onbemande luchtvaartsystemen (UAS) bij bedieners in het frequentiebereik van 5945 tot 6425 MHz in Oostenrijk (AT), België (BE), Bulgarije (BG), Cyprus (CY), Tsjechose Republiek (CZ), Estland (EE), Frankrijk (FR), Duitsland (NL), Island (IS), Ierland (IE), Letland (LV), Luxemburg (LU), Nederland (NL), Noorwegen (NO), Roemenië (RO), Slowakije (SK), Slovenië (SI), Spanje (ES), Zwitserland (CH).

## Lihtsustatud EU vastusdeklaratsioon

Käesolevaga kinnitab ASUSTek Computer Inc, et seade vastab direktiivi 2014/53/EU olulistele nõuetele ja teiste asjakohastele sätetele. ET vastusdeklaratsiooni täisteksti on saadaval veebisaidil <https://www.asus.com/support/>.

Sagedusvahemikus 5150-5350 MHz töötava WiFi kasutamise on järgmistes riikides lubatud ainult siseruumides:

- Madala võimsusega (LPI) Wi-Fi 5.945-6.425 GHz seadmed: Sagedusalas 5945 kuni 6425 MHz töötavate seadmete kasutamine on siseruumides piiratud järgmistes riikides: Austria (AT), Belgia (BE), Bulgaaria (BG), Küproos (CY), Tšehhi Vabariik (CZ), Eesti (EE), Prantsusmaa (FR), Saksamaa (DE), Island (IS), Iirimaa (IE), Läti (LV), Luksemburg (LU), Holland (NL), Norra (NO), Rumeenia (RO), Slovakkia (SK), Sloveenia (SI), Hispaania (ES), Šveits (CH).
- Väga madala võimsusega (VLP) Wi-Fi 5.945-6.425 GHz seadmed (kantavad seadmed): Sagedusalas 5945 kuni 6425 MHz töötavate seadmete kasutamine on mehitatamata õhusüsteemides (UAS) keelatud järgmistes riikides: Austria (AT), Belgia (BE), Bulgaaria (BG), Küproos (CY), Tšehhi Vabariik (CZ), Eesti (EE), Prantsusmaa (FR), Saksamaa (DE), Island (IS), Iirimaa (IE), Läti (LV), Luksemburg (LU), Holland (NL), Norra (NO), Rumeenia (RO), Slovakkia (SK), Sloveenia (SI), Hispaania (ES), Šveits (CH).

## Eurooppa - EYn vaatimustenmukaisuusvaakutus

ASUSTek Computer Inc. ilmoittaa täten, että tämä laite on direktiivin 2014/53/EU olennaisien vaatimusten ja muiden asiaankuuluvien lisäysten mukainen. Koko EYn vaatimustenmukaisuusvaakutuksen teksti on luettavissa osoitteessa <https://www.asus.com/support/>.

5 150 - 5 350 MHz:in tajuudella toimiva WiFi on rajoitettu sisäkäyttöön taulukossa luetteluissa maissa:

- Pienitehoiset sisäkäyttöön (LPI) Wi-Fi 5,945-6,425 GHz-laitteet: Laite on rajoitettu sisäkäyttöön vain, kun se toimii 5945-6425 MHz tajuusalueella Itävalta (AT), Belgiassa (BE), Bulgariassa (BG), Kyproksella (CY), Tšekin tasavallassa (CZ), Virossa (EE), Ranskassa (FR), Saksassa (DE), Islannissa (IS), Irannissa (IE), Latvia (LV), Luxemburg (LU), Alankomaissa (NL), Norja (NO), Romania (RO), Slovakia (SK), Slovenia (SI), Espanjassa (ES), Sveitsi (CH).
- Erittäin pienitehoiset (VLP) Wi-Fi 5,945-6,425 GHz-laitteet (kannettavat laitteet): Laitetta ei saa käyttää miehittämättömissä lentokonejärjestelmissä (UAS) toimittaessa 5945–6425 MHz tajuusalueella Itävalta (AT), Belgiassa (BE), Bulgariassa (BG), Kyproksella (CY), Tšekin tasavallassa (CZ), Virossa (EE), Ranskassa (FR), Saksassa (DE), Islannissa (IS), Irannissa (IE), Latvia (LV), Luxemburg (LU), Alankomaissa (NL), Norja (NO), Romania (RO), Slovakia (SK), Slovenia (SI), Espanjassa (ES), Sveitsi (CH).

## Αποποίησημένη Δήλωση Συμμόρφωσης ΕΕ

Διά το παρόντος η ASUSTek Computer Inc. δηλώνει ότι αυτή η συσκευή είναι σύμμορφη με τις βασικές προϋποθέσεις και άλλες σχετικές διατάξεις της Οδηγίας 2014/53/ΕΕ. Το πλήρες κείμενο της δήλωσης συμμόρφωσης της ΕΕ είναι διαθέσιμο στη διεύθυνση <https://www.asus.com/support/>.

Το WiFi που λειτουργεί στη ζώνη 5150-5350MHz περιορίζεται για χρήση σε εσωτερικούς χώρους για τις χώρες που αναφέρονται στον παρακάτω πίνακα:

- a. Συσκευές Wi-Fi χαμηλής ισχύος για εσωτερικούς χώρους (LPI) 5.945-6.425 GHz

Η συσκευή περιορίζεται σε χρήση σε εσωτερικούς χώρους μόνο όταν λειτουργεί στο εύρος συχνοτήτων 5945 έως 6425 MHz στην Αυστρία (AT), το Βέλγιο (BE), τη Βουλγαρία (BG), την Κύπρο (CY), την Τσεχική Δημοκρατία (CZ), την Εσθονία (EE), τη Γαλλία (FR), τη Γερμανία (DE), την Ισπανία (ES), την Ιρλανδία (IE), τη Λετονία (LV), το Λουξεμβούργο (LU), την Ολλανδία (NL), τη Νορβηγία (NO), τη Ρουμανία (RO), τη Σλοβακία (SK), τη Σλοβενία (SI), την Ισπανία (ES), τη Σουηδία (SE) και την Ελβετία (CH).

- b. Συσκευές Wi-Fi πολύ χαμηλής ισχύος (VLP) 5.945-6.425 GHz (φορητές συσκευές):

Η συσκευή δεν επιτρέπεται να χρησιμοποιείται σε μη επανδρωμένα συστήματα αεροσκαφών (UAS) όταν λειτουργεί στο εύρος συχνοτήτων 5945 έως 6425 MHz στην Αυστρία (AT), το Βέλγιο (BE), τη Βουλγαρία (BG), την Κύπρο (CY), την Τσεχική Δημοκρατία (CZ), την Εσθονία (EE), τη Γαλλία (FR), τη Γερμανία (DE), την Ισπανία (ES), την Ιρλανδία (IE), τη Λετονία (LV), το Λουξεμβούργο (LU), την Ολλανδία (NL), τη Νορβηγία (NO), τη Ρουμανία (RO), τη Σλοβακία (SK), τη Σλοβενία (SI), την Ισπανία (ES), τη Σουηδία (SE) και την Ελβετία (CH).

### הגרת תאימות רגולטורית מקוצרת עבור איחוד אירופי

ASUSTek Computer Inc. מודיעת כי הציוד שלה מתאים לשימוש באזורי התדירות הרדיו 5150-5350MHz. המידע המפורט ברשימה הבאה:

יש להגביל רשתות Wi-Fi הפועלות ברצועת התדרים 5150-5350MHz בתוך מבנים גורמים בצורתן המפורטת ברשימה הבאה:

- a. מכשירי Wi-Fi בעוצמת נמוכה (LPI) 5.945-6.425 GHz בתוך מבנים גורמים בצורתן המפורטת ברשימה הבאה:
- 5945 עד 6425 MHz: צרפת (FR), גרמניה (DE), איטליה (IT), אירלנד (IE), לטביה (LV), לוקסμβורג (LU), הולנד (NL), נורבגיה (NO), רומניה (RO), סלובקיה (SK), סלובניה (SI), שווייץ (CH).

- b. מכשירי Wi-Fi בעוצמת נמוכה (VLP) 5.945-6.425 GHz (מכשירי יד):
- 5945 עד 6425 MHz: אסטוניה (EE), גרמניה (DE), איטליה (IT), אירלנד (IE), לטביה (LV), לוקסμβורג (LU), הולנד (NL), נורבגיה (NO), רומניה (RO), סלובקיה (SK), סלובניה (SI), שווייץ (CH).

### Egyeszerített EU megfelelési nyilatkozat

Az ASUSTek Computer Inc. ezennel kijelenti, hogy ez az eszköz megfelel az 2014/53/EU sz. irányelv alapvető követelményeinek és egyéb vonatkozó rendelkezéseinek. Az EU megfelelési nyilatkozat teljes szövegét a következő weboldalon tekintheti meg: <https://www.asus.com/support/>.

Az 5150-5350 MHz-es sávban működő Wi-Fi-t beltéri használatra kell korlátozni az alábbi táblázatban felsorolt országokban:

- a. Kis teljesítményű, beltéri (LPI) 5,945-6,425 GHz-es Wi-Fi-eszközök: A készülék csak beltéri használatra korlátozódik, ha az 5945-6425 MHz-es frekvenciatarományban működő Ausztria (AT), Belgiumban (BG), Bulgáriában (BG), Cipruson (CY), a Cseh Köztársaságban (CZ), Észtországban (EE), Franciaországban (FR), Németországban (DE), Izlandon (IS), Írországban (IE), Lettország (LV), Luxemburg (LU), Hollandiában (NL), Norvégia (NO), Románia (RO), Szlovákia (SK), Szlovénia (SI), Spanyolországban (ES), illetve Svájc (CH).
- b. Nagyon kis fogyasztású (VLP) 5,945-6,425 GHz-es Wi-Fi-eszközök (horozható eszközök): A készülék nem használható pilóta nélküli légi járműveken (UAS) az 5945-6425 MHz-es frekvenciatarományban Ausztria (AT), Belgiumban (BG), Bulgáriában (BG), Cipruson (CY), a Cseh Köztársaságban (CZ), Észtországban (EE), Franciaországban (FR), Németországban (DE), Izlandon (IS), Írországban (IE), Lettország (LV), Luxemburg (LU), Hollandiában (NL), Norvégia (NO), Románia (RO), Szlovákia (SK), Szlovénia (SI), Spanyolországban (ES), illetve Svájc (CH).

## Vienkāršota ES atbilstības paziņojums

ASUSTek Computer Inc. ar šo paziņo, ka šī ierīce atbilst Direktīvas 2014/53/ES būtiskajām prasībām un citiem citiem saistošajiem nosacījumiem. Pilns ES atbilstības paziņojuma teksts pieejams šeit: <https://www.asus.com/support/>.

Wi-Fi darbība 5150–5350 MHz ir jāierobežo lietošanai telpās valstīs, kuras norādītas tālāk.

- a. Zema enerģijas patēriņa iekārtu (LPI) Wi-Fi 5,945-6,425 GHz ierīces: Ierīce ir paredzēta lietošanai telpās tikai tad, ja tā darbojas 5945 līdz 6425 MHz frekvenču diapazonā Austrijā (AT), Beļģijā (BE), Bulgārijā (BG), Kiprā (CY), Čehijā (CZ), Igaunijā (EE), Francijā (FR), Vācijā (DE), Islandē (IS), Irījā (IE), Latvijā (LV), Luksemburgā (LU), Nīderlandē (NL), Norvēģijā (NO), Rumānijā (RO), Slovēnijā (SI), Spānijā (ES), Šveicē (CH).
- b. Ļoti zema enerģijas patēriņa iekārtu (VLP) Wi-Fi 5,945-6,425 GHz ierīces: Ierīci nav atļauts izmantot bezpilota gaisa kuģu sistēmās (UAS), ja tā darbojas 5945 līdz 6425 MHz frekvenču diapazonā Austrijā (AT), Beļģijā (BE), Bulgārijā (BG), Kiprā (CY), Čehijā (CZ), Igaunijā (EE), Francijā (FR), Vācijā (DE), Islandē (IS), Irījā (IE), Latvijā (LV), Luksemburgā (LU), Nīderlandē (NL), Norvēģijā (NO), Rumānijā (RO), Slovēnijā (SI), Spānijā (ES), Šveicē (CH).

## Supraprista ES atbilstības deklarācija

Šiame dokumente bendrovė „ASUSTek Computer Inc.“ pareiškia, kad šis prietaisas atitinka pagrindinius reikalavimus ir kitas susijusias Direktyvos 2014/53/ES nuostatas. Visas ES atbilstības deklaracijos tekostas pateikiamas čia: <https://www.asus.com/support/>.

Toliau nurodytose šalyse „WiFi“ ryšiu, veikiančiu 5 150-5 350 MHz dažnio juostoje, galima naudotis tik tose šalyse:

- a. Mažos galios, patalpose naudojami (angl. Low Power Indoor – LPI) „Wi-Fi“ 5.945–6.425 GHz įrenginiai:  
Šį įrenginį galima naudoti tik patalpose, kai jis veikia 5 945–6 425 MHz dažnių diapazone Austrija (AT), Belgijoje (BE), Bulgarijoje (BG), Kipre (CY), Čekijoje (CZ), Estijoje (EE), Prancūzijoje (FR), Vokietijoje (DE), Islandijoje (IS), Airijoje (IE), Latvija (LV), Liuksemburgas (LU), Nyderlanduose (NL), Norvegijoje (NO), Rumunija (RO), Slovakijoje (SK), Slovėnija (SI), Ispanijoje (ES), Šveicarija (CH).
- b. Labai mažos, patalpose naudojami (angl. Very Low Power – VLP) „Wi-Fi“ 5.945–6.425 GHz įrenginiai (nešiojamieji įrenginiai):  
Šio įrenginio neleidžiama naudoti bepilotui orlaiviu sistemose (UAS), kai jis veikia 5 945–6 425 MHz dažnių diapazone Austrija (AT), Belgijoje (BE), Bulgarijoje (BG), Kipre (CY), Čekijoje (CZ), Estijoje (EE), Prancūzijoje (FR), Vokietijoje (DE), Islandijoje (IS), Airijoje (IE), Latvija (LV), Liuksemburgas (LU), Nyderlanduose (NL), Norvegijoje (NO), Rumunija (RO), Slovakijoje (SK), Slovėnija (SI), Ispanijoje (ES), Šveicarija (CH).

## Forenklet EU-samsvarserklärning

ASUSTek Computer Inc. erklærer herved at denne enheten er i samsvar med hovedsaklige krav og andre relevante forskrifter i direktivet 2014/53/EU. Fullstendig tekst for EU-samsvarserklæringen finnes på: <https://www.asus.com/support/>.

Wi-Fi-området 5150–5350 MHz skal begrenses til innendørs bruk for landene som er oppført i tabellen:

- a. Laveffekt innendørs (LPI) Wi-Fi 5,945–6,425 GHz-enheter: Enheten er begrenset til kun innendørs bruk når den brukes i frekvensområdet 5945 til 6425 MHz i Østerrike (AT), Belgia (BE), Bulgaria (BG), Kypros (CY), Tsjekia (CZ), Estland (EE), Frankrike (FR), Tyskland (DE), Island (IS), Irland (IE), Latvia (LV), Luxembourg (LU), Nederland (NL), Norge (NO), Romania (RO), Slovakia (SK), Slovenia (SI), Spania (ES) og Sveits (CH).
- b. Veldig lavstrøms (VLP) Wi-Fi 5,945–6,425 GHz-enheter (bærbare enheter): Enheten får ikke brukes på ubemannede flysystemer (UAS) når den brukes i frekvensområdet 5945 til 6425 MHz i Østerrike (AT), Belgia (BE), Bulgaria (BG), Kypros (CY), Tsjekia (CZ), Estland (EE), Frankrike (FR), Tyskland (DE), Island (IS), Irland (IE), Latvia (LV), Luxembourg (LU), Nederland (NL), Norge (NO), Romania (RO), Slovakia (SK), Slovenia (SI), Spania (ES) og Sveits (CH).

## Uproszczona deklaracja zgodności UE

Firma ASUSTek Computer Inc. niniejszym oświadcza, że urządzenie to jest zgodne z zasadniczymi wymogami i innymi właściwymi postanowieniami dyrektywy 2014/53/EU. Pełny tekst deklaracji zgodności UE jest dostępny pod adresem <https://www.asus.com/support/>.

W krajach wymienionych w tabeli działaniu sieci Wi-Fi w paśmie 5150–5350 MHz powinno być ograniczone wyłącznie do pomieszczeń:

- Urządzenia Wi-Fi o niskim poziomie mocy w pomieszczeniach (LPI) w zakresie 5,945–6,425 GHz:  
W Austrii (AT), Belgii (BE), Bułgarii (BG), Cyprze (CY), Czechach (CZ), Estonii (EE), Francji (FR), Niemczech (DE), Islandii (IS), Irlandii (IE), Lotwie (LV), Luksemburgu (LU), Holandii (NL), Norwegii (NO), Rumunii (RO), Słowacji (SK), Słowenii (SI), Hiszpanii (ES) i Szwajcarii (CH) działanie urządzeń w zakresie częstotliwości od 5945 do 6425 MHz jest ograniczone do użytku wewnątrz pomieszczeń.
- Urządzenia Wi-Fi o bardzo niskim poziomie mocy (VLP) w zakresie 5,945–6,425 GHz (urządzenia przenośne):  
W Austrii (AT), Belgii (BE), Bułgarii (BG), Cyprze (CY), Czechach (CZ), Estonii (EE), Francji (FR), Niemczech (DE), Islandii (IS), Irlandii (IE), Lotwie (LV), Luksemburgu (LU), Holandii (NL), Norwegii (NO), Rumunii (RO), Słowacji (SK), Słowenii (SI), Hiszpanii (ES) i Szwajcarii (CH) urządzenie działające w zakresie częstotliwości od 5945 do 6425 MHz nie może być używane w bezzałogowych systemach latających (UAS).

## Declaração de Conformidade Simplificada da UE

A ASUSTek Computer Inc. declara que este dispositivo está em conformidade com os requisitos essenciais e outras disposições relevantes da Diretiva 2014/53/UE. O texto integral da declaração de conformidade da UE está disponível em <https://www.asus.com/support/>.

A utilização das frequências WiFi de 5150 a 5350MHz está restrita a ambientes interiores nos países apresentados na tabela:

- Dispositivos Wi-Fi 5,945-6,425 GHz de baixa potência para interiores (LPI):  
O dispositivo restringe-se à utilização em locais interiores apenas quando funcionar na gama de frequências de 5945 a 6425 MHz na Áustria (AT), Bélgica (BE), Bulgária (BG), Chipre (CY), República Checa (CZ), Estónia (EE), França (FR), Alemanha (DE), Islândia (IS), Irlanda (IE), Letónia (LV), Luxemburgo (LU), Países Baixos (NL), Noruega (NO), Roménia (RO), Eslováquia (SK), Eslovénia (SI), Espanha (ES), Suíça (CH).
- Dispositivos Wi-Fi 5,945-6,425 GHz de muito baixa potência (VLP) (dispositivos portáteis):  
Não é permitida a utilização do dispositivo em veículos aéreos não tripulados (UAS) quando o mesmo funcionar na gama de frequências de 5945 a 6425 MHz na Áustria (AT), Bélgica (BE), Bulgária (BG), Chipre (CY), República Checa (CZ), Estónia (EE), França (FR), Alemanha (DE), Islândia (IS), Irlanda (IE), Letónia (LV), Luxemburgo (LU), Países Baixos (NL), Noruega (NO), Roménia (RO), Eslováquia (SK), Eslovénia (SI), Espanha (ES), Suíça (CH).

## Declaratie de conformitate UE, versiune simplificată

Prin prezenta, ASUSTek Computer Inc. declară că acest dispozitiv este în conformitate cu reglementările esențiale și cu celelalte prevederi relevante ale Directivei 2014/53/UE. Textul complet al declarației de conformitate UE este disponibil la adresa <https://www.asus.com/support/>.

Pentru țările listate în tabelul de mai jos, rețeaua WiFi care funcționează în banda de frecvență de 5.150-5.350 MHz trebuie utilizată doar în interior:

- Dispozitive Wi-Fi cu consum redus de energie pentru interior (LPI) de 5,945-6,425 GHz:  
Dispozitivul este restricționat pentru utilizare exclusiv în interior atunci când funcționează în gama de frecvențe de la 5945 la 6425 MHz în Austria (AT), Belgia (BE), Bulgaria (BG), Cipru (CY), Republica Cehă (CZ), Estonia (EE), Franța (FR), Germania (DE), Islanda (IS), Irlanda (IE), Letonia (LV), Luxemburg (LU), Țările de Jos (NL), Norvegia (NO), România (RO), Slovacia (SK), Slovenia (SI), Spania (ES), Switzerland (CH).
- Dispozitive Wi-Fi de foarte mică putere (VLP) de 5,945-6,425 GHz (dispozitive portabile):  
Nu este permisă utilizarea dispozitivului pe sisteme de aeronave fără pilot la bord (UAS) atunci când funcționează în gama de frecvențe 5945-6425 MHz în Austria (AT), Belgia (BE), Bulgaria (BG), Cipru (CY), Republica Cehă (CZ), Estonia (EE), Franța (FR), Germania (DE), Islanda (IS), Irlanda (IE), Letonia (LV), Luxemburg (LU), Țările de Jos (NL), Norvegia (NO), România (RO), Slovacia (SK), Slovenia (SI), Spania (ES), Switzerland (CH).

## Pojednostavljena Deklaracija o usaglasenosti EU

ASUSTek Computer Inc. ovim izjavlja da je ovaj uređaj usaglašen sa osnovnim zahtevima i drugim relevantnim odredbama Direktive 2014/53/EU. Ceo tekst Deklaracije o usaglasenosti EU dostupan je na lokaciji <https://www.asus.com/support/>.

WiFi koji radi u frekventnom opsegu od 5150 MHz do 5350 MHz ograničen je isključivo na upotrebu u zatvorenom prostoru za zemlje navedene u tabeli ispod:

- Wi-Fi 5.945-6.425 GHz uređaji s niskom potrošnjom za zatvoreni prostor (LPI):  
Ovaj uređaj je ograničen na upotrebu samo u zatvorenom prostoru kada radi u frekventnom opsegu od 5945 do 6425 MHz u Austriji (AT), Belgiji (BE), Bugarskoj (BG), Cipru (CY), Češkoj Republici (CZ), Estoniji (EE), Francuskoj (FR), Nemačkoj (DE), Islandu (IS), Irskoj (IE), Letoniji (LV), Luksemburgu (LU), Holandiji (NL), Norveška (NO), Rumunija (RO), Slovačka (SK), Slovenija (SI), Španiji (ES), Švajcarska (CH).
- Wi-Fi 5.945-6.425 GHz uređaji s veoma niskom potrošnjom (VLP) (prenosivi uređaji):  
Nije dozvoljeno da se ovaj uređaj koristi na sistemima bespilotnih letelica (UAS) kada radi u frekventnom opsegu od 5945 do 6425 MHz u Austriji (AT), Belgiji (BE), Bugarskoj (BG), Cipru (CY), Češkoj Republici (CZ), Estoniji (EE), Francuskoj (FR), Nemačkoj (DE), Islandu (IS), Irskoj (IE), Letoniji (LV), Luksemburgu (LU), Holandiji (NL), Norveška (NO), Rumunija (RO), Slovačka (SK), Slovenija (SI), Španiji (ES), Švajcarska (CH).

## Zjednodušené vyhlásenie o zhode platné pre EÚ

Spoločnosť ASUSTek Computer Inc. týmto vyhlasuje, že toto zariadenie je v súlade so základnými požiadavkami a ďalšími príslušnými ustanoveniami smernice č. 2014/53/EU. Plné znenie vyhlásenia o zhode pre EÚ je k dispozícii na lokalite <https://www.asus.com/support/>.

Činnosť WiFi v pásme 5150 - 5350 MHz bude obmedzená na použitie vo vnútornom prostredí pre krajiny uvedené v tabuľke nižšie:

- Zariadenia s Wi-Fi 5,945 - 6,425 GHz s nízkym výkonom určené do vnútorného prostredia (LPI):  
Toto zariadenie je obmedzené len na použitie vo vnútornom prostredí pri prevádzke vo frekvenčnom pásme 5945 až 6425 MHz v Rakúsku (AT), Belgicku (BE), Bulharsku (BG), na Cypru (CY), v Českej republike (CZ), Estónsku (EE), vo Francúzsku (FR), Nemecku (DE), na Islande (IS), v Írsku (IE), Lotyšsku (LV), Luxemburgu (LU), Holandsku (NL), Nórsku (NO), Rumunsko (RO), Slovensku (SK), Slovinsku (SI), Španielsku (ES), Švajčiarsku (CH).
- Zariadenia s Wi-Fi 5,945 - 6,425 GHz s veľmi nízkym výkonom (VLP) (prenosné zariadenia):  
Toto zariadenie sa nesmie používať v bezpilotných leteckých systémoch (UAS) pri prevádzke vo frekvenčnom pásme 5945 až 6425 MHz v Rakúsku (AT), Belgicku (BE), Bulharsku (BG), na Cypru (CY), v Českej republike (CZ), Estónsku (EE), vo Francúzsku (FR), Nemecku (DE), na Islande (IS), v Írsku (IE), Lotyšsku (LV), Luxemburgu (LU), Holandsku (NL), Nórsku (NO), Rumunsko (RO), Slovensku (SK), Slovinsku (SI), Španielsku (ES), Švajčiarsku (CH).

## Poenostavljena izjava EU o skladnosti

ASUSTek Computer Inc. tukaj izjavlja, da je ta naprava skladna s temeljnimi zahtevami in drugimi relevantnimi določili Direktive 2014/53/EU. Polno besedilo izjave EU o skladnosti je na voljo na <https://www.asus.com/support/>.

WiFi, ki deluje v pasovnem območju 5150-5350 MHz, mora biti v državah, navedenih v spodnjem seznamu, omejen na notranjo uporabo:

- Notranje naprave z nizko močjo (LPI) Wi-Fi 5,945-6,425 GHz:  
Naprava je omejena na uporabo v zaprtih prostorih, kadar deluje v frekvenčnem območju 5945 do 6425 MHz v Avstriji (AT), Belgiji (BE), Bolgariji (BG), na Cipru (CY), Češkem (CZ), v Estoniji (EE), Franciji (FR), Nemčiji (DE), na Islandiji (IS), Irskem (IE), v Latviji (LV), Luksemburgu (LU), na Nizozemskem (NL), Norveški (NO), Romuniji (RO), Slovaški (SK), Sloveniji (SI), Španiji (ES), Švica (CH).
- Naprave z zelo nizko močjo (VLP) Wi-Fi 5,945-6,425 GHz (prenosne naprave):  
Naprave ni dovoljeno uporabljati v sistemih brezpilotnih zrakoplovo (UAS), kadar delujejo v frekvenčnem območju 5945 do 6425 MHz v Avstriji (AT), Belgiji (BE), Bolgariji (BG), na Cipru (CY), Češkem (CZ), v Estoniji (EE), Franciji (FR), Nemčiji (DE), na Islandiji (IS), Irskem (IE), v Latviji (LV), Luksemburgu (LU), na Nizozemskem (NL), Norveški (NO), Romuniji (RO), Slovaški (SK), Sloveniji (SI), Španiji (ES), Švica (CH).



### Declaración de conformidad simplificada para la UE

Por la presente, ASUSTek Computer Inc. declara que este dispositivo cumple los requisitos básicos y otras disposiciones pertinentes de la directiva 2014/53/EU. En <https://www.asus.com/support/>, está disponible el texto completo de la declaración de conformidad para la UE.

La conexión WiFi con una frecuencia de funcionamiento de 5150-5350 MHz se restringirá al uso en interiores para los países enumerados en la tabla:

- Dispositivos con Wi-Fi de baja potencia para interiores (LPI) de 5,945-6,425 GHz  
El dispositivo está restringido al uso en interiores únicamente cuando funciona en el intervalo de frecuencias de 5945 a 6425 MHz en Austria (AT), Bélgica (BE), Bulgaria (BG), Chipre (CY), República Checa (CZ), Estonia (EE), Francia (FR), Alemania (DE), Islandia (IS), Irlanda (IE), Letonia (LV), Luxemburgo (LU), Países Bajos (NL), Noruega (NO), Rumanía (RO), Eslovaquia (SK), Eslovenia (SI), España (ES) y Suiza (CH).
- Dispositivos con Wi-Fi de muy baja potencia (VLP) de 5,945-6,425 GHz (dispositivos portátiles):  
No está permitido usar el dispositivo en sistemas de aeronaves no tripuladas cuando funciona en el intervalo de frecuencias de 5945 a 6425 MHz en Austria (AT), Bélgica (BE), Bulgaria (BG), Chipre (CY), República Checa (CZ), Estonia (EE), Francia (FR), Alemania (DE), Islandia (IS), Irlanda (IE), Letonia (LV), Luxemburgo (LU), Países Bajos (NL), Noruega (NO), Rumanía (RO), Eslovaquia (SK), Eslovenia (SI), España (ES) y Suiza (CH).

### Förenklad EU-försäkran om överensstämmelse

ASUSTek Computer Inc. deklarerar härmed att denna enhet överensstämmer med de grundläggande kraven och andra relevanta bestämmelser i direktiv 2014/53/EU. Fullständig text av EU-försäkran om överensstämmelse finns på <https://www.asus.com/support/>.

WiFi som används 5150-5350 MHz kommer att begränsas för användning inomhus i de länder som anges i tabellen:

- Wi-Fi-enheter 5,945-6,425 GHz med låg effekt inomhus (LPI):  
Enheten är begränsad till användning inomhus enbart när den använder 5 945 till 6 425 MHz frekvensband i Österrike (AT), Belgien (BE), Bulgarien (BG), Cypern (CY), Tjeckien (CZ), Estland (EE), Frankrike (FR), Tyskland (DE), Island (IS), Irland (IE), Lettland (LV), Luxemburg (LU), Nederländerna (NL), Norge (NO), Rumänien (RO), Slovakien (SK), Slovenien (SI), Spanien (ES), Schweiz (CH).
- Wi-Fi-enheter 5,945-6,425 GHz med mycket låg effekt (VLP) (bärbara enheter):  
Enheten får inte användas på obemannade luftfartyg (UAS) när den använder 5 945 till 6 425 MHz frekvensband i Österrike (AT), Belgien (BE), Bulgarien (BG), Cypern (CY), Tjeckien (CZ), Estland (EE), Frankrike (FR), Tyskland (DE), Island (IS), Irland (IE), Lettland (LV), Luxemburg (LU), Nederländerna (NL), Norge (NO), Rumänien (RO), Slovakien (SK), Slovenien (SI), Spanien (ES), Schweiz (CH).

### Basitleştirilmiş AB Uyumluluk Bildirimi

ASUSTek Computer Inc., bu aygıtın 2014/53/EU Yönergesinin temel gereksinimlerine ve diğer ilgili hükümlerine uygun olduğunu bildirir. AB uygunluk bildirimimin tam metni şu adreste bulunabilir: <https://www.asus.com/support/>.

5150-5350 MHz aralısındaki WiFi çalışması, tabloda listelenen ülkeler için iç mekân kullanımıyla kısıtlanacaktır.

- Düşük Güç İç Mekan (LPI) Wi-Fi 5.945-6.425 GHz cihazları:  
Avusturya (AT), Belçika (BE), Bulgaristan (BG), Kıbrıs (CY), Çek Cumhuriyeti (CZ), Estonya (EE), Fransa (FR), Almanya (DE), İzlanda (IS), İrlanda (IE), Letonya (LV), Lüksemburg (LU), Hollanda (NL), Norveç (NO), Romanya (RO), Slovakya (SK), Slovenya (SI), İspanya (ES), İsviçre (CH)'da 5945 ila 6425 Mhz frekans aralığında çalışırken cihaz yalnızca iç mekânda kullanımı ile sınırlanmıştır.
- Bek Düşük Güç (VLP) Wi-Fi 5.945-6.425 GHz cihazları (taşınabilir cihazlar):  
Avusturya (AT), Belçika (BE), Bulgaristan (BG), Kıbrıs (CY), Çek Cumhuriyeti (CZ), Estonya (EE), Fransa (FR), Almanya (DE), İzlanda (IS), İrlanda (IE), Letonya (LV), Lüksemburg (LU), Hollanda (NL), Norveç (NO), Romanya (RO), Slovakya (SK), Slovenya (SI), İspanya (ES), İsviçre (CH)'da 5945 ila 6425 Mhz frekans aralığında çalışırken cihazın Sansız Hava Aracı Sistemleri (UAS)'ta kullanımı iznini değildir.

### Спрошена декларация про відповідність нормам ЄС

ASUSTek Computer Inc. заявляє, що цей пристрій відповідає основним вимогам та іншим відповідним директивам Директиви 2014 / 53 / EU. Повний текст декларації відповідності нормам ЄС доступний на <https://www.asus.com/support/>.

Робота Wi-Fi на частоті 5150-5350 МГц обмежується використанням у приміщенні для країн, поданих у таблиці нижче:

- Пристрої низької потужності для приміщень (LPI) Wi-Fi 5,945-6,425 ГГц  
Використання пристрою обмежено лише приміщенням із діапазоном частот від 5945 МГц до 6425 МГц у Австрії (AT), Бельгії (BE), Болгарії (BG), на Кіпрі (CY), у Чеській Республіці (CZ), Естонії (EE), Франції (FR), Німеччині (DE), Ірландії (IE), Іспанії (ES), Італії (IT), Латвії (LV), Люксембурзі (LU), Нідерландах (NL), Норвегії (NO), Румунії (RO), Словаччині (SK), Словенії (SI), Іспанії (ES), Швейцарії (CH).
- Пристрої дуже низької потужності (VLP) Wi-Fi 5,945-6,425 ГГц (портативні пристрої).  
Використання пристрою не дозволено на безпілотних літальних апаратах (UAS) із діапазоном частот від 5945 МГц до 6425 МГц у Австрії (AT), Бельгії (BE), Болгарії (BG), на Кіпрі (CY), у Чеській Республіці (CZ), Естонії (EE), Франції (FR), Німеччині (DE), Ірландії (IE), Іспанії (ES), Італії (IT), Латвії (LV), Люксембурзі (LU), Нідерландах (NL), Норвегії (NO), Румунії (RO), Словаччині (SK), Словенії (SI), Іспанії (ES), Швейцарії (CH).



AT	BE	BG	CZ	DK	EE	FR
DE	IS	IE	IT	EL	ES	CY
LV	LI	LT	LU	HU	MT	NL
NO	PL	PT	RO	SI	SK	TR
FI	SE	CH	HR	UK(NI)		

### CE RED RF Output table (Directive 2014/53/EU)

Model: MT7927

Function	Frequency	Maximum Output Power EIPR (mW)
WiFi	2.4 - 2.4835 GHz	<100
	5.15 - 5.35 GHz	<200
	5.47 - 5.725 GHz	<200
	5.725 - 5.875 GHz*	<25
	5.925 - 6.425 GHz	<200
Bluetooth	2.4 - 2.4835 GHz	<100

### Receiver category 1

\* Non-Intel modules: 5.725 - 5.85 GHz

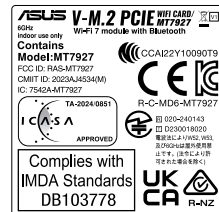

# Warranty

## EN: ASUS Guarantee Information

- ASUS offers a voluntary manufacturer's Commercial Guarantee.
- ASUS reserves the right to interpret the provisions of the ASUS Commercial Guarantee.
- This ASUS Commercial Guarantee is provided independently and in addition to the statutory Legal Guarantee and in no way affects or limits the rights under the Legal Guarantee.

For all the guarantee information, please visit <https://www.asus.com/support>.

## F: Garantie ASUS

- ASUS fournit une garantie commerciale en tant que garantie volontaire du fabricant.
- ASUS se réserve le droit d'interpréter et de clarifier les informations relatives à la garantie commerciale ASUS.
- Cette garantie commerciale ASUS est fournie indépendamment et parallèlement à la garantie légale, elle n'affecte ou ne limite d'aucune façon les droits acquis par la garantie légale.

Pour plus d'informations sur la garantie, consultez le site <https://www.asus.com/fr/support/>.

## G: ASUS Garantiefinformationen

- ASUS bietet eine freiwillige Warengarantie des Herstellers an.
- ASUS behält sich das Recht zur Auslegung der Bestimmungen in der ASUS Warengarantie vor.
- Diese ASUS Warengarantie wird unabhängig und zusätzlich zur rechtmäßigen gesetzlichen Garantie gewährt und beschränkt in keiner Weise die Rechte aus der gesetzlichen Garantie.

Die vollständigen Garantieinformationen finden Sie unter <https://www.asus.com/de/support/>.

## I: Informativa sulla Garanzia ASUS

- ASUS offre una Garanzia Commerciale volontaria del produttore.
- ASUS si riserva il diritto di interpretare le disposizioni della Garanzia Commerciale ASUS.
- La presente Garanzia Commerciale ASUS viene fornita in modo indipendente e in aggiunta alla Garanzia Legale prevista per legge e non pregiudica o limita in alcun modo i diritti previsti dalla Garanzia Legale.

Per tutte le informazioni sulla garanzia, visitare <https://www.asus.com/it/support>.

## R: Информация о гарантии ASUS

- ASUS предлагает добровольную гарантию от производителя.
- ASUS оставляет за собой право интерпретирование положений гарантии ASUS.
- Настоящая гарантия ASUS никоим образом не ограничивает Ваш выбор, предусмотренные локальным законодательством.

Для получения полной информации о гарантии посетите <https://www.asus.com/ru/support/>.

## BG: Информация за гаранцията от ASUS

- ASUS предлага доброволна търговска гаранция от производителя.
- ASUS си запазва правото да тълкува условията на търговската гаранция на ASUS.
- Тази търговска гаранция на ASUS се предлага независимо от и в допълнение на законната гаранция. Тя по никакъв начин не оказва влияние върху правата на потребителя в законната гаранция и по никакъв начин не ги ограничава.

За цялостна информация относно гаранцията, моля, посетете <https://www.asus.com/support>.

## CR: Informacije o ASUS jamstvu

- ASUS dragovoljno nudi komercijalno proizvođačko jamstvo.
- ASUS zadržava prava na tumačenje odredbi ASUS komercijalnog jamstva.
- Ovo ASUS komercijalno jamstvo daje se neovisno i kao dodatak zakonskom jamstvu i ni na koji način ne ograničuje prava iz okvira zakonskog jamstva.

Sve informacije o jamstvu potražite na <https://www.asus.com/support>.

## CZ: Informace o záruce společnosti ASUS

- Společnost ASUS nabízí dobrovolnou komerční záruku výrobce.
- Společnost ASUS si vyhrazuje právo vykládat ustanovení komerční záruky společnosti ASUS.
- Tato komerční záruka společnosti ASUS je poskytována nezávisle a jako doplněk zákonné záruky a žádným způsobem neovlivňuje ani neomezuje práva vyplývající ze zákonné záruky.

Všechny informace o záruce najdete na adrese <https://www.asus.com/cz/support/>.

## DA: ASUS garantioplysninger

- ASUS tilbyder en valgfri handelsmæssig garanti.
- ASUS forbeholder sig retten til at fortolke bestemmelserne i ASUS' handelsmæssige garanti.
- Denne handelsmæssige garanti fra ASUS tilbydes uafhængigt, som en tilføjelse til den lovbestemte juridiske garanti og den påvirker eller begrænser på ingen måde rettighederne i den juridiske garanti.

Alle garantioplysningerne kan findes på <https://www.asus.com/dk/support/>.

## DU: ASUS-garantie-informatie

- SUS biedt een vrijwillige commerciële garantie van de fabrikant.
- ASUS behoudt zich het recht voor om de bepalingen van de commerciële garantie van ASUS uit te leggen.
- Deze commerciële garantie van ASUS wordt onafhankelijk en als aanvulling op de statutaire Wettelijke garantie geboden en beïnvloedt of beperkt in geen geval de rechten onder de wettelijke garantie.

Voor alle informatie over de garantie, gaat u naar <https://www.asus.com/nl/support/>.

## EE: Teave ASUS-e garantii kohta

- ASUS pakub vabataltlikku tasulist tootjagarantii.
- ASUS endale õiguse tõlgendada ASUS-e tasulise garantii tingimusi.
- See ASUS-e tasuline garanti on sõltumatu lisagarantii seadusega kehtestatud garantii ega mõjuta mingil määral seadusega kehtestatud garantiid ning seadusega kehtestatud garantii piiranguid.

Vaadake garantiiiga seotud teavet veebisaidil <https://www.asus.com/ee/>.

## FI: ASUS-takuutiedot

- ASUS tarjoaa vapaaehtoisena valmistajan kaupallisen takuun.
- ASUS pidättää oikeuden tulkita ASUS-kaupallisen takuun ehdot.
- Tämä ASUS-kaupallinen takuu tarjotaan itsenäisesti lakisääteisen oikeudellisen takuun lisäksi eikä se vaikuta millään tavoin laillisen takuun oikeuksiin tai rajoita niitä.

Saadaksesi kaikki takuutiedot, siirry osoitteeseen <https://www.asus.com/fi/support>.

## GK: Πληροφορίες εγγύησης ASUS

- Η ASUS προσφέρει μια εθελοντική Εμπορική εγγύηση κατασκευαστή.
- Η ASUS διατηρεί το δικαίωμα ερμηνείας των διατάξεων της Εμπορικής εγγύησης ASUS.
- Αυτή η Εμπορική εγγύηση ASUS παρέχεται ανεξάρτητα και επιπροσθέτως της θεσμικής Νομικής εγγύησης και σε καμία περίπτωση δεν επηρεάζει ή περιορίζει τα δικαιώματα βάσει της Νομικής εγγύησης.

Για όλες τις πληροφορίες εγγύησης, επισκεφθείτε τη διεύθυνση <https://www.asus.com/gr-el/>.

## HUG: ASUS garanciális információk

- Az ASUS önkéntes gyártói kereskedelmi garanciát kínál.
- Az ASUS fenntartja magának a jogot, hogy értelmezze az ASUS kereskedelmi garanciára vonatkozó rendelkezéseket.
- Ezt a kereskedelmi garanciát az ASUS függetlenül és a törvényes garancia mellett nyújtja és semmilyen módon nem befolyásolja, vagy korlátozza a jogi garancia nyújtotta jogokat.

A garanciára vonatkozó teljes körű információkért látogasson el a <https://www.asus.com/hu/support/oldalra>.

## LT: Informacija apie ASUS garantiją

- ASUS siūlo savanorišką komercinę gamintojo garantiją.
- ASUS pasilieka teisę savo nuožūria aiškinti šios komercinės ASUS garantijos nuostatas.
- Ši komercinė ASUS garantija suteikiama nepriklausoma, be įstatyminės teisinės garantijos, ir jokiu būdu nepaveikia ar neapriboja teisinės garantijos suteikiamų teisių.

Norėdami gauti visą informaciją apie garantiją, apsilankykite <https://www.asus.com/lt/>.

## LV: ASUS garantijas informācija

- ASUS piedāvā brīvprātīgu ražotāja komerciālo garantiju.
- ASUS patur tiesības interpretēt ASUS komerciālās garantijas noteikumus.
- Šī ASUS komerciālā garantija tiek piedāvāta neatkarīgi un papildus likumā noteiktajai juridiskajai garantijai, un tā nekādā veidā neietekmē vai neierobežo juridiskajā garantijā noteiktās tiesības.

Lai iegūtu informāciju par garantiju, apmeklējiet vietni <https://www.asus.com/lv/>.

#### **MX: Garantía y Soporte**

Esta Garantía aplica en el país de compra. Usted acepta que en esta garantía:

- Los procedimientos de servicio pueden variar en función del país.
- Algunos servicios y/o piezas de reemplazo pudieran no estar disponibles en todos los países.
- Algunos países pueden tener tarifas y restricciones que se apliquen en el momento de realizar el servicio, visite el sitio de soporte de ASUS en <https://www.asus.com/mx/support/> para ver más detalles.
- Si tiene alguna queja o necesidad de un centro de reparación local o el periodo de garantía del producto ASUS, por favor visite el sitio de Soporte de ASUS en <https://www.asus.com/mx/support/> para mayores detalles.

#### **Información de contacto ASUS**

Esta garantía está respaldada por:  
ASUSTeK Computer Inc.  
Centro de Atención ASUS +52 (55) 1946-3663

#### **NW: Informasjon om ASUS-garanti**

- ASUS tilbyr som produsent en frivillig kommersiell garanti.
- ASUS forbeholder seg retten til å tolke bestemmelsene i ASUS sin kommersielle garanti.
- ASUS sin kommersielle garanti gis uavhengig og i tillegg til den lovbestemte juridiske garantien, og verken påvirker eller begrenser rettighetene under den juridiske garantien på noen måte.

Du finner fullstendig informasjon om garanti på <https://www.asus.com/no/support/>.

#### **PG: Informações de Garantia ASUS**

- A ASUS oferece uma Garantia Comercial voluntária do fabricante.
- A ASUS reserva o direito de interpretar as disposições da Garantia Comercial da ASUS.
- Esta Garantia Comercial da ASUS é fornecida de forma independente além da Garantia Legal estatutária e não afeta nem limita de qualquer forma os direitos estabelecidos na Garantia Legal.

Para consultar todas as informações sobre a garantia, visite <https://www.asus.com/pt/support/>.

#### **PL: Informacje o gwarancji firmy ASUS**

- Firma ASUS oferuje dobrowolną gwarancję handlową producenta.
- Firma ASUS zastrzega sobie prawo do interpretacji warunków gwarancji handlowej firmy ASUS.
- Niniejsza gwarancja handlowa firmy ASUS jest udzielana niezależnie, jako dodatek do wymaganej ustawowo gwarancji prawnej i w żaden sposób nie wpływa na prawa przysługujące na mocy gwarancji prawnej ani ich nie ogranicza.

Wszelkie informacje na temat gwarancji można znaleźć na stronie <https://www.asus.com/pl/support/>.

#### **RO: Informații despre garanția ASUS**

- ASUS oferă o garanție comercială voluntară a producătorului.
- ASUS își rezervă dreptul de a interpreta prevederile garanției comerciale ASUS.
- Această garanție comercială ASUS este oferită independent și în plus față de garanția obligatorie legală și nu afectează sau limitează în niciun fel drepturile acordate conform garanției legale.

Pe toate informațiile legate de garanție, vizitați <https://www.asus.com/ro/support/>.

#### **S: Información de garantía de ASUS**

- ASUS ofrece una garantía comercial voluntaria del fabricante.
- ASUS se reserva el derecho de interpretar las disposiciones de esta garantía comercial de ASUS.
- Esta garantía comercial de ASUS se proporciona de forma independiente y adicional a la garantía estatutaria y de ninguna manera afecta a los derechos bajo la garantía legal ni los limita.

Para obtener toda la información sobre la garantía, visite <https://www.asus.com/ES/support/>.

#### **SB: Informacije o ASUS garanciji**

- ASUS nudi dobrowolnu proizvođačku komercijalnu garanciju.
- ASUS zadržava pravo da tumači odredbe svoje ASUS komercijalne garancije.
- Ova ASUS komercijalna garancija daje se nezavisno, kao dodatak zakonskoj pravnoj garanciji, i ni ka koji način ne utiče na i ne ograničava prava data pravnom garancijom.

Za sve informacije o garanciji, posetite <https://www.asus.com/support/>.

#### **SK: Informácie o záruke ASUS**

- ASUS ponúka dobrovoľnú obchodnú záruku výrobcu.
- ASUS si vyhradzuje právo interpretovať ustanovenia obchodnej záruky ASUS.
- Táto obchodná záruka ASUS je poskytnutá nezávisle a navyše k zákonnej záruke a v žiadnom prípade neovplyvňuje ani neobmedzuje tieto práva podľa tejto zákonnej záruky.

Všetky ďalšie informácie o záruke nájdete na <https://www.asus.com/sk/support/>.

#### **SL: Informacije o garanciji ASUS**

- ASUS ponuja prostovoljno tržno garancijo proizvajalca.
- ASUS si pridržuje pravico do razlage določb tržne garancije družbe ASUS.
- Ta tržna garancija družbe ASUS je na voljo neodvisno in kot dodatek zakonsko predpisani pravni garanciji ter na noben način ne vpliva na pravice, ki jih zagotavlja pravna garancija, oziroma jih omejuje.

Vse informacije o garanciji najdete na spletnem mestu <https://www.asus.com/support/>.

#### **SW: ASUS garantinformation**

- ASUS erbjuder en frivillig kommersiell tillverkningsgaranti.
- ASUS förbehåller sig rätten att tolka bestämmelserna i ASUS kommersiella garanti.
- Denna kommersiella garanti från ASUS tillhandahålls separat och som tillägg till den lagstadgade garantin, och påverkar eller begränsar på intet sätt rättsigheterna under den lagstadgade garantin.

För all garantiinformation, besök <https://www.asus.com/se/support/>.

#### **TR: ASUS Garanti Bilgileri**

- ASUS, gönüllü olarak üretici Ticari Garantisi sunar.
- ASUS, ASUS Ticari Garantisinin hükümlerini yorumlama hakkını saklı tutar.
- Bu ASUS Ticari Garantisi, bağımsız olarak ve hukuki Yasal Garanti'ye ek olarak sağlanır ve hiçbir şekilde Yasal Garanti kapsamındaki hakları etkilemez veya sınırlamaz.

Tüm garanti bilgileri için lütfen <https://www.asus.com/tr/support/> adresini ziyaret edin.

#### **UA: Інформація про Гарантію ASUS**

- ASUS пропонує добровільну Комерційну Гарантію виробника.
- ASUS застерігає за собою право тлумачити положення Комерційної Гарантії ASUS.
- Цю Комерційну Гарантію надано незалежно і на додаток до обов'язкової Законної Гарантії вона жодним чином не впливає на права за Законовою Гарантією і не обмежує їх.

Всю інформацію про гарантію подано тут: <https://www.asus.com/ua/support/>.

Компанія ASUS не несе відповідальності за шкоду, заподіяну життю, здоров'ю чи майну користувача або інших осіб внаслідок використання несправного Виробу або такого Виробу, що не пройшов діагностику після закінчення терміну служби.

З метою перевірки технічного стану Виробу та визначення безпеки його подальшого використання після закінчення терміну служби користувачу необхідно припинити використання Виробу та передати його в авторизований сервісний центр компанії ASUS протягом одного місяця з моменту виявлення пошкодження та/або закінчення терміну служби Виробу.

#### **BP: Informações de garantia ASUS**

Esta garantía aplica-se ao período definido pela garantia legal (90 dias) mais o período de garantia comercial oferecido pela ASUS. Por exemplo: 12M significa 12 meses de garantia no total (3 meses de garantia legal mais 9 meses de garantia contratual), 24 meses significa 24 meses de garantia no total (3 meses de garantia legal mais 21 meses de garantia contratual) e 36 meses significa 36 meses de garantia no total (3 meses de garantia legal e 33 de garantia contratual) a contar da data da garantia declarada (Data de Inicio da Garantia).

Para todas as informações de garantia, visite <https://www.asus.com/bt/support/>.

**ID: Informasi Garansi ASUS**

Garansi ini berlaku di negara tempat pembelian.

Periode Garansi tertera pada kemasan/kotak dari Produk dan Masa Garansi dimulai sejak tanggal pembelian Produk ASUS dengan kondisi baru.

Silahkan pindai Kode di bagian bawah halaman terakhir untuk Kartu Garansi versi Web dalam format PDF untuk lebih informasi jelas mengenai jaminan garansi Produk ASUS.

- Informasi Dukungan ASUS, silakan kunjungi <https://www.asus.com/id/support>.
- Informasi Lokasi Layanan, silakan kunjungi <https://www.asus.com/id/support/Service-Center/Indonesia>.
- Layanan Call Center: 1500128

**VN: Thông tin đảm bảo của ASUS**

- ASUS cung cấp Bảo hành thương mại tự nguyện của nhà sản xuất.
- ASUS bảo lưu quyền giải thích các điều khoản của Bảo hành thương mại của ASUS.
- Bảo hành thương mại này của ASUS được cung cấp độc lập và ngoài Bảo đảm pháp lý theo luật định và không có cách nào ảnh hưởng đến hoặc giới hạn các quyền theo Bảo lãnh pháp lý. Để biết tất cả các thông tin bảo hành, vui lòng truy cập

<https://www.asus.com/vn/support>

**ASUS מידע על אחריות :HB**

- ASUS מציעה אחריות מסחרית של יצרן מוצן.
- ASUS שמרת לעצמה את הזכות לפרש את הוראות הערבות המסחרית של ASUS.
- אחריות מסחרית זו של ASUS ניתנת באופן עצמאי ובנוסף לערבות המשפטית הטסטוטורית ואינה משפיעה או מגבילה בשום אופן את הזכויות במסגרת הערבות המשפטית.

למידע אודות האחריות, אנא בקר ב <https://www.asus.com/support>



Warranty Card (Online)

## ASUS contact information

### ASUSTeK COMPUTER INC.

Address: 1F., No. 15, Lide Rd., Beitou Dist., Taipei City 112  
<https://qr.asus.com/ProductSafety>

### ASUS COMPUTER INTERNATIONAL (America)

Address: 48720 Kato Rd., Fremont, CA 94538, USA

### ASUS COMPUTER GmbH (Germany and Austria)

Address: Harkortstrasse 21-23, 40880 Ratingen, Germany

### ASUSTeK (UK) LIMITED

Address: 1st Floor, Sackville House, 143-149 Fenchurch Street, London, EC3M 6BL,  
England, United Kingdom

### ASUS GLOBAL PTE. LTD.

Address: 10 Changi Business Park Central 2 #02-01 Hansapoint Singapore 486030  
<https://qr.asus.com/ProductSafety>

## Service and support

Visit our multi-language website at <https://www.asus.com/support>.



## Product register

Log in and register your device for better product support.



