

# LIMAZ

## PRODUCT CATALOG

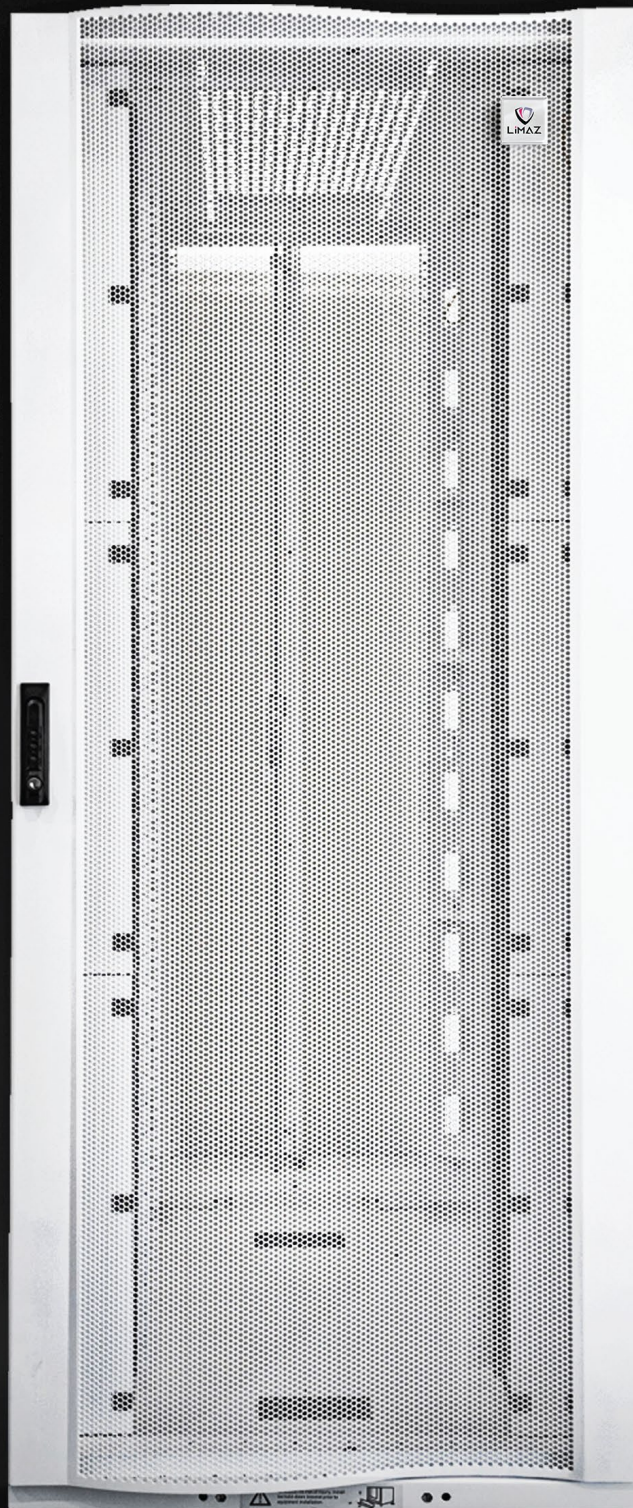

[admin@ninedistribution.com](mailto:admin@ninedistribution.com)



[limazthailand](https://www.facebook.com/limazthailand)



02-678-9199



[www.limaz.co.th](http://www.limaz.co.th)

# Index

## OVERVIEW

LIMAZ	2
LIMAZ Solution	3
Site Reference	4

## COPPER SOLUTION

LAN Cable CAT 5E	6
LAN Cable CAT 6	8
LAN Cable CAT 6A	10
LAN Connector	12
LAN Patch Panel	14
LAN Patch Cord	16
LAN Face Plate	17
Cable Management	18
LAN Accessories	19
LAN Tool	20

## FIBER OPTIC SOLUTION

Fiber Optic Cable Indoor	22
Fiber Optic Cable In/Out, ADSS, ARSS	24
HD Patch Panel & Accessories	26
HD Adapter Plate, MPO Cassette	28
UHD Patch Panel	30
UHD Adapter Tray	31
Patch Cord & Pigtail	32
MPO Cable	33
Optical Module	34
FTTX Cable	36
FTTX Fast Installed Connector	37
Wall Outlet & PLC Splitter	38
Termination Box	39

## RACK CABINET

LC Pure White Series	41
LCB Pure White Series	43
LWC Pure White Series	44
LC Black Series	46
LCK Black Series	48
LCB Black Series	50
LWC Black Series	52
Cold Containment	54
Electronic Lock	56

## POWER DISTRIBUTION UNIT

Basic PDU	57
Local Metered PDU	58
Monitored PDU	59
Switched PDU	60



# OVERVIEW

---



**“ลิมซ์”** ผลิตภัณ์ที่ระบบสายสัญญาณเน็ตเวิร์ค  
คุณภาพสูง (Network Infrastructure System) แบบנד  
คนไทย มาตรฐานสากล รับประกันสินค้า 25 ปี เหมาะกับผู้ใช้  
งานทั่วไป จนถึงงานระดับดาต้าเซ็นเตอร์(Data Center)

เรามีสินค้าครบทั้งระบบครอบคลุมโซลูชั่นทั้งหมดแบบ  
End-to-End ในหมวดหมู่ผลิตภัณ์ที่แตกต่างกัน มีทีมงาน  
ที่เชี่ยวชาญเฉพาะทาง ตอบโจทย์ทุกความต้องการของผู้ใช้  
งาน

เพราะทุกวันนี้ อินเทอร์เน็ตมีความสำคัญต่อชีวิตในหลายๆ  
ด้าน และเทคโนโลยีมีการพัฒนาตลอดเวลา จึงต้องก้าว  
กระโดดให้เท่าทัน เราพร้อมให้คำปรึกษากับลูกค้า อัปเดตเทรน  
เทคโนโลยี ให้ความสำคัญกับการพัฒนาสินค้าให้พร้อมรองรับ  
เทคโนโลยีแห่งอนาคต

เรามีบริการก่อนและหลังการขาย หลักสูตรอบรมการใช้  
งานสินค้า ตลอดไปจนถึงการอบรมพื้นฐานระบบสายสัญญาณ



LIMAZ SYSTEM WARRANTY  
25 YEARS

# LIMAZ SOLUTIONS

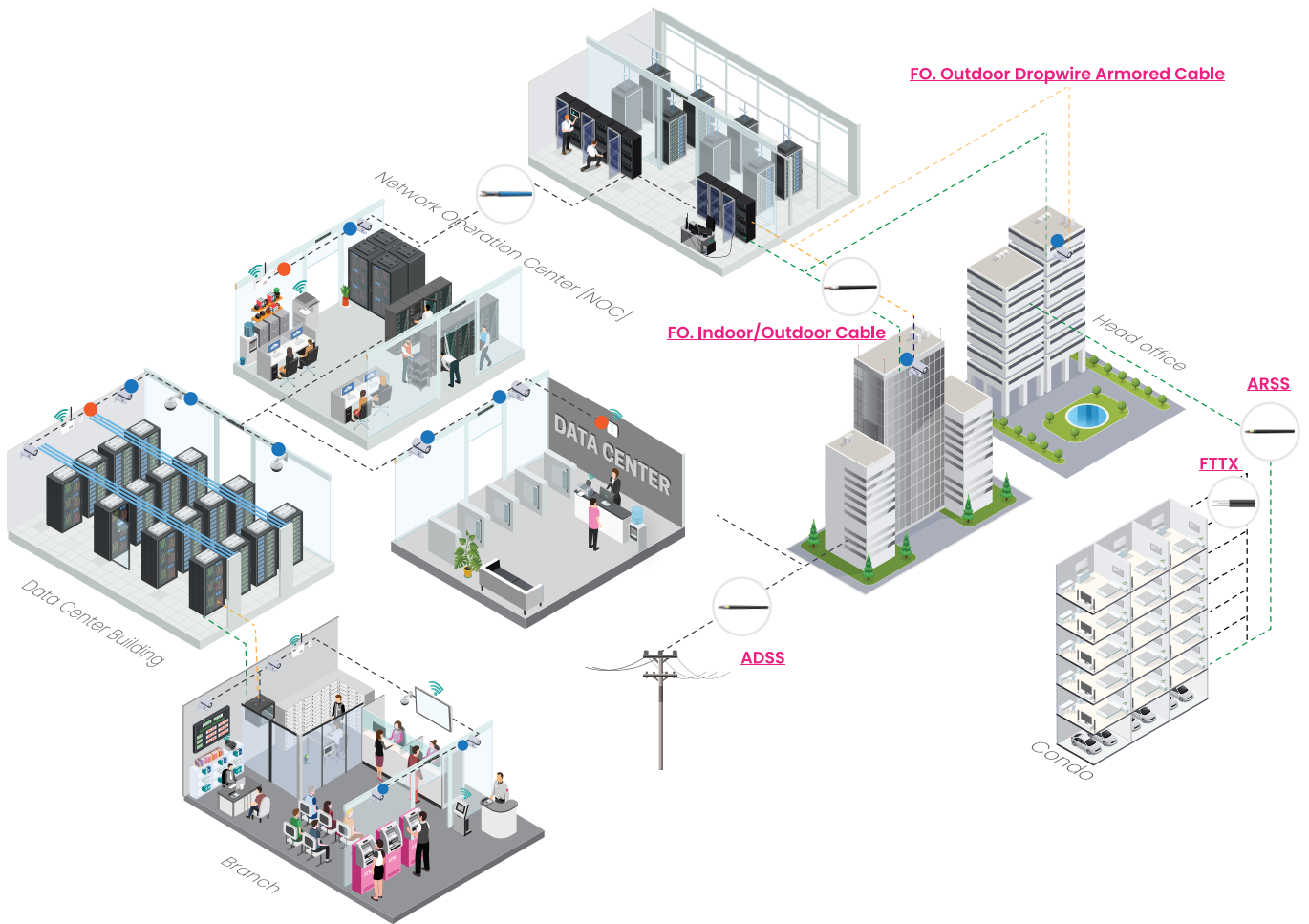

“ Complete Solution for Structure Cabling. ”

**STANDARD**





## มหาวิทยาลัย และสถานศึกษา



## หน่วยงานราชการและรัฐวิสาหกิจ



## ธนาคาร และสถาบันการเงิน





## โรงพยาบาล



## บริษัทเอกชน

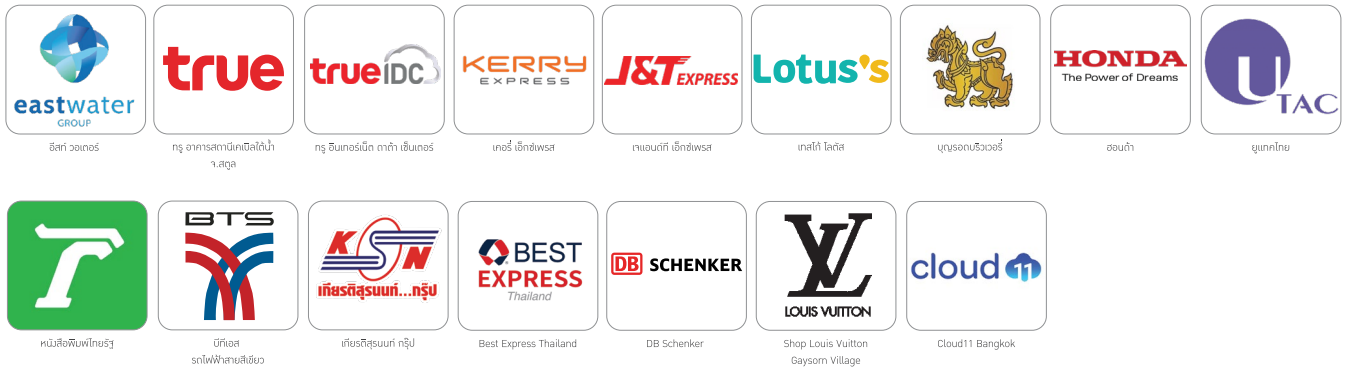

## คอนโด อสังหาริมทรัพย์



# LAN Cable

## CAT 5E

### Indoor Cable & Outdoor Cable



**LMZ-LUC5EWH**

CM, CMR, LSZH  
24 AWG

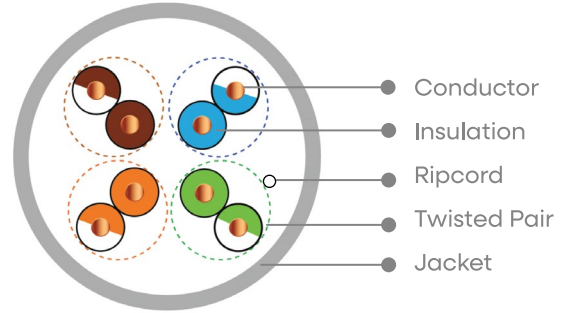

**LMZ-LOC5EDBL**

PE  
24 AWG

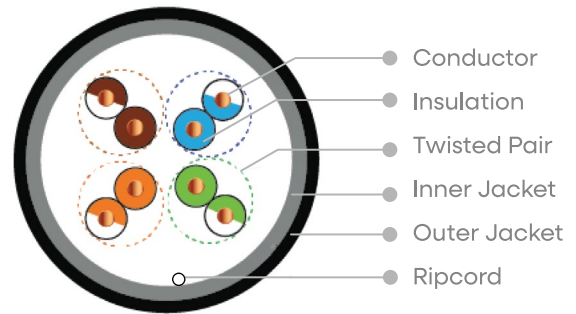

**LMZ-LOC5EBL**

PE  
24 AWG

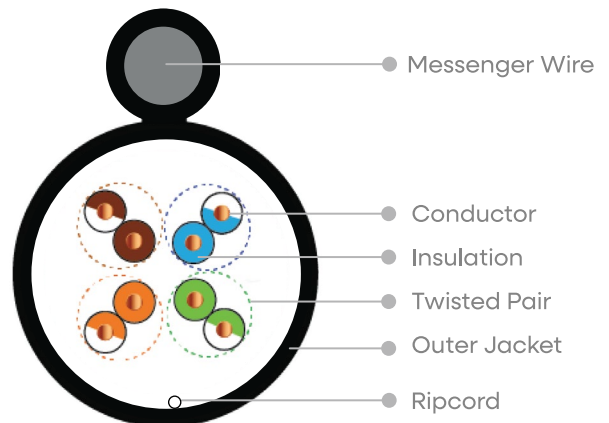

**Jacket Color**

Indoor : White (WH)

Outdoor : Black (BL)



## General Specification

Cable Type	U/UTP (Unshielded)
Pairs, quantity	4
Conductor Material	Solid Bare Copper
Conductor Gauge	24 AWG
Insulation Material	HDPE
Jacket Material	FR-PVC : CM, CMR, LSZH [Indoor]   PE [Outdoor]
Operating Temp	-20°C to + 60°C



## Electrical Performance

Cabling Standard	ANSI/TIA-568.2-D
Bandwidth	100 MHz
Main Ethernet Application(100m)	1Gbps
Type of use	IP CCTV, IP Phone



## Ordering Number

Part Number	Description	Cable Type	Cable Diameter	Packaging	Price
LMZ-LUC5EWH	U/UTP CAT 5E Cable 24 AWG	CM, Indoor	~ 5,3 mm.	Box	<b>5,350.-</b>
LMZ-LOC5EDBL	U/UTP CAT 5E Outdoor Cable, Double Jacket	PE, Outdoor	~ 6,4 mm.	Reel	<b>Call</b>
LMZ-LOC5EBL	U/UTP CAT 5E Outdoor Cable, Dropwire	PE, Outdoor	~ 5,5 mm.	Reel	<b>Call</b>



# LAN Cable

## CAT 6

### Indoor Cable & Outdoor Cable



**LMZ-LUU06-CBU**

24 AWG  
Tested 250MHz



**LMZ-LUU06-BU**  
**LMZ-LUU06-PBU**  
**LMZ-LUU06-LBU**

23AWG  
Tested 350MHz

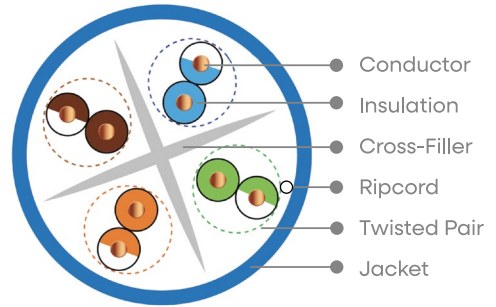

**LMZ-LUU06-DBL**

PE  
23 AWG

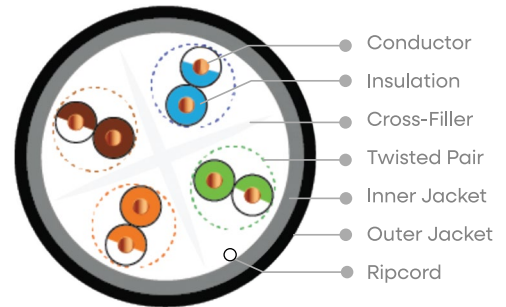

**LMZ-LUU06-MBL**

PE  
23 AWG

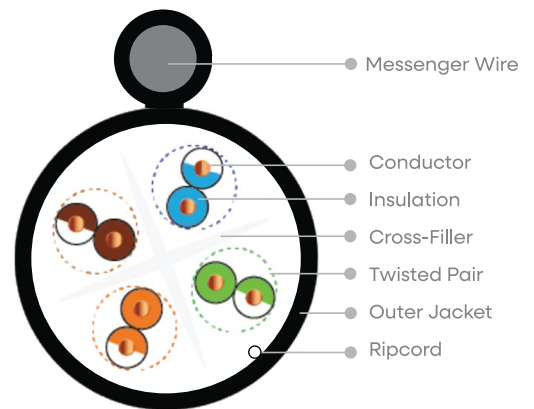

#### Jacket Color

##### Standard Color

- Indoor : Blue (BU)
- Outdoor : Black (BL)

##### Special Color MOQ 36 Box/Color

- Indoor : White (WH) Gray (GY) Black (BL)
- Red (RD) Yellow (YL) Green (GR)



## General Specification

Cable Type	U/UTP (Unshielded), F/UTP (Shielded)
Pairs, quantity	4
Conductor Material	Solid Bare Copper
Conductor Gauge	23, 24 AWG
Insulation Material	HDPE
Jacket Material	FR-PVC : CM, CMR, CMP, LSZH [Indoor]   PE [Outdoor]
Operating Temp.	-20°C to + 60°C



## Electrical Performance

Cabling Standard	ANSI/TIA-568.2-D
Bandwidth	CAT6 250 MHz, CAT6+ 350 MHz
Main Ethernet Application(100m)	1, 2.5, 5 Gbps
Type of use	IP CCTV, IP Phone, Access Point ,PoE Solution



## Ordering Number

Part Number	Description	Cable Type	Cable Diameter	Packaging	Price
LMZ-LUU06-CBU	U/UTP CAT 6 Cable 24 AWG	CM, Indoor	~ 5.9 mm.	Box	<b>6,150.-</b>
LMZ-LUU06-BU	U/UTP CAT 6 Cable 23 AWG	CMR, Indoor	~ 6.0 mm.	Box	<b>6,750.-</b>
LMZ-LUU06-PBU	U/UTP CAT 6 Cable 23 AWG	<b>&lt;DUPONT&gt;</b> CMP, Indoor	~ 6.0 mm.	Box	<b>Call</b>
LMZ-LUU06-LBU	U/UTP CAT 6 Cable 23 AWG	LSZH, Indoor	~ 6.0 mm.	Box	<b>6,900.-</b>
LMZ-LUU06-DBL	U/UTP CAT 6 Outdoor Cable, Double Jacket	PE, Outdoor	~ 7.5 mm.	Reel	<b>8,400.-</b>
LMZ-LUU06-MBL	U/UTP CAT 6 Outdoor Cable, Dropwire	PE, Outdoor	~ 6.3 mm.	Reel	<b>8,400.-</b>

Tested 350MHz



**Reelex** : เป็นระบบบรรจุสายเคเบิลแบบพิเศษที่ช่วยป้องกันการพัน และการแตกหักของสายขณะใช้งาน กล่อง Reelex ออกแบบมาเพื่อให้สายเคเบิลสามารถดึงออกมาได้ง่ายและไม่พันกัน



REELEX®



Parallel Wind



Spool



# LAN Cable

## CAT 6A Indoor Cable



**LMZ-LUU6A-WH**

23 AWG  
Uncontinuous Foil

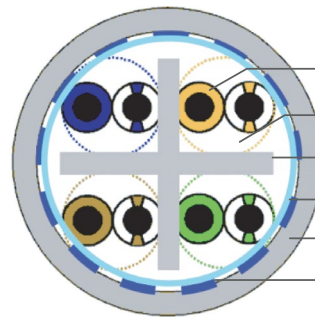

- Insulated Conductor
- Twisted Pair
- Separator
- PS Tape (Optional)
- Outer sheath
- Non-continuous Aluminum Tape



- ▶ Data Center
- ▶ Multi Gigabit/Wi-Fi6 Solution



**LMZ-LFU6A -GY**

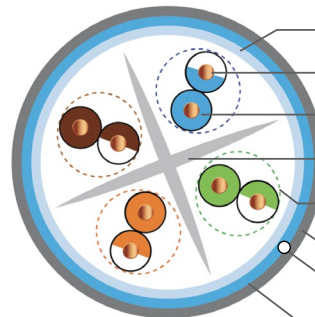

- PET Foil
- Conductor
- Insulation
- Cross - Filler
- Twisted Pair
- Jacket
- Ripcord
- Foil Shield

### Jacket Color

Standard Color

Indoor : White (WH)

Special Color MOQ 36 Box/Color

Indoor : Blue (BU) Gray (GY) Black (BL)  
Red (RD) Yellow (YL) Green (GR)



## General Specification

Cable Type	U/UTP (Unshielded),F/UTP (Shielded)
Pairs, quantity	4
Conductor Material	Solid Bare Copper
Conductor Gauge	23 AWG
Insulation Material	HDPE
Jacket Material	FR-PVC : CMR, CMP, LSZH [Indoor]
Operating Temp.	-20°C to + 60°C



## Electrical Performance

Cabling Standard	ANSI/TIA-568.2-D
Bandwidth	500 MHz
Main Ethernet Application(100m)	1, 2.5, 5, 10 Gbps
Type of use	IP CCTV, IP Phone, Access Point ,PoE Solution



## Ordering Number

Part Number	Description	Cable Type	Cable Diameter	Packaging	Price
LMZ-LUU6A-WH	U/UTP CAT 6A Cable 23 AWG	CMR, Indoor	~7.2 mm.	Reel	<b>8,500.-</b>
LMZ-LUU6A -PBU	U/UTP CAT 6A Cable 23 AWG	CMP, Indoor	~7.2 mm.	Reel	<b>Call</b>
LMZ-LUU6A-LWH	U/UTP CAT 6A Cable 23 AWG	LSZH, Indoor	~7.2 mm.	Reel	<b>8,600.-</b>
LMZ-LFU6A -GY	F/UTP CAT 6 Cable 23 AWG	CMR, Shield, Indoor	~7.0 mm.	Reel	<b>9,150.-</b>
LMZ-LFU6A -PGY	F/UTP CAT 6 Cable 23 AWG	CMP, Shield, Indoor	~7.0 mm.	Reel	<b>Call</b>
LMZ-LFU6A -LGY	F/UTP CAT 6 Cable 23 AWG	LSZH, Shield, Indoor	~7.0 mm.	Reel	<b>9,200.-</b>

# LAN Connector

## RJ45 Modular Jack



LMZ-MJANC6BU

👍 Best Price



LMZ-MJANC6WH

👍 Best Price

CAT 6  
High Performance



LMZ-MJAKC6BU

👍 Data Center

CAT 6A  
High Performance & Future

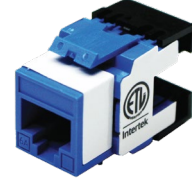

LMZ-MJAKC6ABU

👍 Data Center



### General Specification

Product Type	RJ45 Modular Jack
Category	5E, 6, 6A
Cable Type	Unshield, Shield
Housing Material	Polycarbonate, UL94V-0
Contact Material	Phosphor Bronze, Gold Plated 50 microinch
IDC Termination	Phosphor Bronze, Tin over Nickel undercoat
Wiring	T568A, T568B
Safety Standard	UL
Operating Tem.	-20°C to +60°C
Special	Unique Spring, AK Series

### Ordering Number

Part Number	Description	Type	Price
LMZ-MJAKC5EWH	RJ45 Modular Jack CAT 5E, AK Series	Unshield	90.-
LMZ-MJAKC6XX	RJ45 Modular Jack CAT 6, AK Series	Unshield	150.-
LMZ-MJANC6XX	RJ45 Modular Jack CAT 6, AN Series	Unshield	95.-
LMZ-MJAKC6AXX	RJ45 Modular Jack CAT 6A, AK Series	Unshield	200.-
LMZ-MJSAC6AXX	Shield RJ45 Modular Jack CAT 6A, SA Series	Shield	350.-

Color (XX) :



## RJ45 Modular Plug and Boot



**LMZ-MP5**  
Material : Polycarbonate



**LMZ-CB5**  
Material : Rubber



**LMZ-MPS6A**  
Shield Tool Less



**LMZ-MP6**  
Details : Polycarbonate



**LMZ-CB6**  
Material : Polycarbonate



**LMZ-MPH6A**  
Unshield Tool Less



### General Specification

Product Type	RJ45 Modular Plug
Housing Material	Polycarbonate, UL94V-0
Contact Blade	Copper Alloy, Gold Plated 50 Microinch
Conductor Type	Solid & Stranded
Mechanical	750 Cycles Minimum
Operating Temp	-20°C to +60°C

### Ordering Number

Part Number	Description	Price
LMZ-MP5	RJ45 Modular Plug CAT 5E	<b>10.-</b>
LMZ-CB5	Rubber Boot CAT 5E, Clear	<b>8.-</b>
LMZ-MP6	RJ45 Modular Plug CAT 6, Angle Latch	<b>16.-</b>
LMZ-CB6	Boot CAT 6, Clear	<b>8.-</b>
LMZ-MPS6A	Shield RJ45 Modular Plug CAT 6A, Tool Less	<b>350.-</b>
LMZ-MPH6A	Unshield RJ45 Modular Plug CAT 6A, Tool Less	<b>300.-</b>

# LAN Patch Panel

## Patch Panel



**LMZ-MPPF24**  
Front Access



**LMZ-LPU24A**  
Front Access and Angled

 Best Price



**LMZ-MPPM24**  
Front Access



**LMZ-MPP24**  
Shielded and Unshielded



### General Specification

Product Type	RJ45 Patch Panel Unload
Product Material	Polycarbonate, Steel
Total Port, quantity	24
Compatible Jack	LIMAZ AK Series, AN Series
Rack Units	1
Management	Rear Support Bar
Operating Temp	-20°C to +60°C

## Ordering Number

Part Number	Description	Special	Price
LMZ-MPPF24	Patch Panel 24 Port, Unload, Front Access	Front Access	<b>1,600.-</b>
LMZ-LPU24A	Angled, Front Panel For LMZ-MPPF24	Front Access	<b>1,500.-</b>
LMZ-MPP24	Shield Patch Panel 24 Port, Unload	Unshield/Shield	<b>1,050.-</b>
LMZ-MPPM24	Patch Panel 24 Port, Unload, Module Series	Front Access	<b>1,200.-</b>





# LAN Patch Cord

## RJ45 Patch Cord

 Data Center



LMZ-PC06BU03



LMZ-PCL6ABU03



LMZ-PC06YYXX-SD

28 AWG, Small Diameter



### General Specification

Product Type	RJ45 Patch Cord
ANSI/TIA Category	CAT 5E, 6, 6A
Cable Type	U/UTP (Unshield)
Connector A	RJ45 Plug
Connector B	RJ45 Plug
Conductor	Stranded Bare Copper 24 AWG, 28 AWG (Small Diameter)
Wiring	T568B
Flammability Rating	CM, LSZH
Operating Temp	-20°C to +60°C

### Ordering Number

Part Number	Description	Price : (1m.)	(2m.)	(3m.)	(5m.)	(10m.)	(Add 1m.)
LMZ-PC5EYYXX	UTP CAT 5E, Patch Cord 24 AWG PVC	90.-	135.-	180.-	270.-	365.-	20.-
LMZ-PC06YYXX	UTP CAT 6, Patch Cord 24 AWG PVC	100.-	150.-	200.-	300.-	550.-	50.-
LMZ-PCL06YYXX	UTP CAT 6, Patch Cord 24 AWG LSZH	105.-	155.-	205.-	310.-	575.-	55.-
LMZ-PC06YYXX-SD	UTP CAT 6, Small Diameter Patch Cord 28 AWG PVC	115.-	170.-	220.-	325.-	570.-	50.-
LMZ-PCL06YYXX-SD	UTP CAT 6, Small Diameter Patch Cord 28 AWG LSZH	120.-	175.-	230.-	335.-	600.-	55.-
LMZ-PC6AYYXX	UTP CAT 6A, Patch Cord 24 AWG PVC	150.-	230.-	310.-	465.-	835.-	75.-
LMZ-PCL6AYYXX	UTP CAT 6A, Patch Cord 24 AWG LSZH	155.-	235.-	315.-	475.-	880.-	80.-
LMZ-PC6AYYXX-S	STP CAT 6A, Small Diameter Patch Cord 26 AWG PVC	175.-	255.-	335.-	490.-	875.-	90.-
LMZ-PCL6AYYXX-S	STP CAT 6A, Small Diameter Patch Cord 26 AWG LSZH	185.-	265.-	350.-	510.-	920.-	90.-
LMZ-PC6AYYXX-SD	UTP CAT 6A, Small Diameter Patch Cord 28 AWG PVC	170.-	265.-	355.-	535.-	960.-	85.-
LMZ-PCL6AYYXX-SD	UTP CAT 6A, Small Diameter Patch Cord 28 AWG LSZH	180.-	270.-	360.-	545.-	1000.-	90.-

**Length (xx) :** 1F( 1 Feet ), 01( 1m. ), 02( 2m. ), ...

**Jacket Color(YY) :** Blue (BU) White (WH) Black (BL) Gray (GY) Green (GR) Red (RD) Yellow (YL)

# LAN Face Plate

Face Plate    

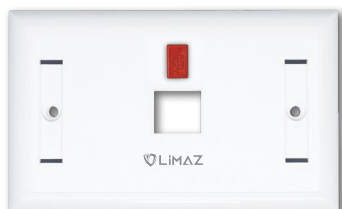

**LMZ-FP1S**

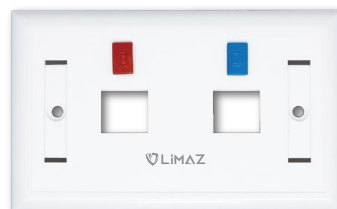

**LMZ-FP2S**



**LMZ-FP1SS**



**LMZ-FP2SS**



## General Specification

Product Type	RJ45 Face Plate
ANSI/TIA Category	CAT 5E, 6, 6A
Application	Used with LIMAZ RJ45 Modular Jack
Material Type	High-impact, Flame Retardant, Thermoplastic
Flammability Rating	UL 94 V-0
Operating Temp	-20°C to +60°C

## Ordering Number

Part Number	Description	Price
LMZ-FP1S	Face Plate 1 Port with Icon & Label	40.-
LMZ-FP2S	Face Plate 2 Port with Icon & Label	40.-
LMZ-FP4S	Face Plate 4 Port with Icon & Label	45.-
LMZ-FP1SS	Shutter Face Plate 1 Port with Icon & Label	50.-
LMZ-FP2SS	Shutter Face Plate 2 Port with Icon & Label	50.-

# Cable Management



LMZ-HCM1U

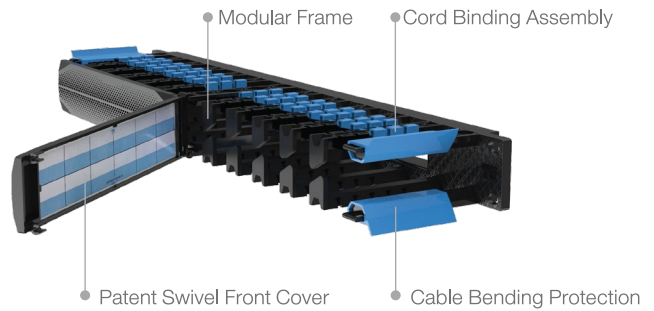

LMZ-HCM1U-V2



LMZ-BP1U

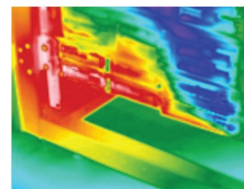

BEFORE

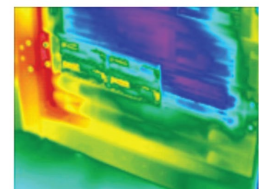

AFTER

BLANK PANEL แผ่นปิดช่องลมของลิมาซเป็นแบบTool Less สามารถยึดติดกับเสา U โดยไม่ต้องใช้เครื่องมือ เป็นตัวช่วยควบคุมการไหลของอากาศ โดยป้องกันไม่ให้อากาศร้อนที่ถูกระบายออกจากอุปกรณ์ ไหลกลับเข้ามาทางด้านหน้าของ Rack ป้องกันฝุ่นและสิ่งแปลกปลอมเข้า Rack ช่วยให้ดูเป็นระเบียบเรียบร้อยมากขึ้น



## General Specification

Product Type	Cable Management
Application	Manage Cable, Snap-on Covers are easy to use and Open 180° up or down
Material Type	Steel + Plastic T Shaped
Rack Unit	1
Operating Temp	-20°C to +60°C

### Ordering Number

Part Number	Description	Price
LMZ-HCM1U	Cable Management with Cover	950.-
LMZ-HCM1U-V2	Cable Management with Cover Gen. 2	950.-
LMZ-BP1U	Tool Less Blank Panel 1U, Black	250.-

# LAN Accessories

## Velcro Tape

Velcro Tape คือ เทปตีนตุ๊กแก (Hook and Loop) ซึ่งสามารถยึดติดกับได้อย่างแน่นหนาและถอดออกได้ง่าย ด้วยดีไซน์ที่ออกแบบมาให้สามารถปรับใช้ได้ตามต้องการ จัดเก็บง่าย จะช่วยให้การจัดการสายไฟ หรือการจัดเก็บสิ่งต่างๆ เป็นเรื่องง่ายและสะดวก ดูเรียบร้อยเป็นระเบียบยิ่งขึ้น



LMZ-VD1245BL

LMZ-VD2045BU



### General Specification

Product Type	Velcro Tape
Material	Polyamide (Nylon)
Width	12, 20 mm.
Packaging	45 m.
Color	Black, Blue, Purple, Red, Yellow
Operating Temp	-20°C to +60°C

### Ordering Number

Part Number	Description	Color	Packing (m.)	Price
LMZ-VD1245BL	LIMAZ Velcro Tape 12 mm., Black	Black	45	<b>1,300.-</b>
LMZ-VD1245BU	LIMAZ Velcro Tape 12 mm., Blue	Blue	45	<b>1,300.-</b>
LMZ-VD1245PP	LIMAZ Velcro Tape 12 mm., Purple	Purple	45	<b>1,300.-</b>
LMZ-VD1245RD	LIMAZ Velcro Tape 12 mm., Red	Red	45	<b>1,300.-</b>
LMZ-VD1245YL	LIMAZ Velcro Tape 12 mm., Yellow	Yellow	45	<b>1,300.-</b>
LMZ-VD2045BL	LIMAZ Velcro Tape 20 mm., Black	Black	45	<b>1,900.-</b>
LMZ-VD2045BU	LIMAZ Velcro Tape 20 mm., Blue	Blue	45	<b>1,900.-</b>
LMZ-VD2045PP	LIMAZ Velcro Tape 20 mm., Purple	Purple	45	<b>1,900.-</b>
LMZ-VD2045RD	LIMAZ Velcro Tape 20 mm., Red	Red	45	<b>1,900.-</b>
LMZ-VD2045YL	LIMAZ Velcro Tape 20 mm., Yellow	Yellow	45	<b>1,900.-</b>

# LAN Tool

## Crimping Tool for RJ45 Plug CAT 5E, 6



### General Specification

Product Type	RJ45 Crimp Tool
Category	5E, 6
Crimp Application	RJ45 Modular Plug
Feature	Crimp & Trim In One Time, Cut Cable, Strip Cable
Operating Temp	-10°C to +50°C

### Ordering Number

Part Number	Description	Price
LMZ-TP01	LIMAZ Crimping Tool for RJ45 Plug CAT 5E,6	<b>3,200.-</b>
LMZ-TP01-Cutting Blade	LIMAZ Cutting Blade for LMZ-TP01	<b>50.-</b>

# LAN Tool



**LMZ-TJAK**



**LMZ-TJAN**



## General Specification

Product Type	Modular Jack Tool
Category	5E, 6, 6A
Application	LIMAZ Modular Jack AK, AN Series
Contact Compatibility	Accommodates 22 to 24 AWG Solid
Operating Temp	-10°C to +50°C

## Ordering Number

Part Number	Description	Price
LMZ-TJAK	LIMAZ Modular Jack Termination Tool for AK Series	<b>3,500.-</b>
LMZ-TJAN	LIMAZ Modular Jack Termination Tool for AN Series	<b>3,500.-</b>

# Fiber Optic Cable

## Indoor Cable

### LSZH



#### Fiber Optic Indoor Singlemode

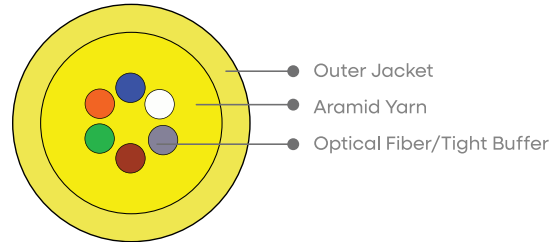

#### Fiber Optic Indoor Multimode

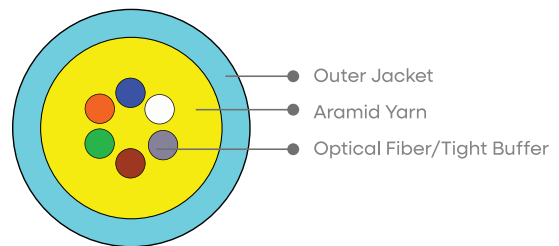

#### General Specification

Product Type	Fiber Optic Indoor Cable
Application	Indoor/Intra-building/Datacenter
Construction Type	Non-armored
Fiber Type	Singlemode (OS2); ITU-T G.652D Multimode (OM3, OM4); ITU-T G.651
Fiber Quantity	6, 12, 24, 48, 60, 72, 96 core
Strength Member	Aramid Yarn
Jacket Color	Yellow (OS2), Aqua (OM3, OM4)
Flame Test Listing	LSZH
Operating Temp	-20°C to +60°C

#### Optical Fiber Cabling Color Code

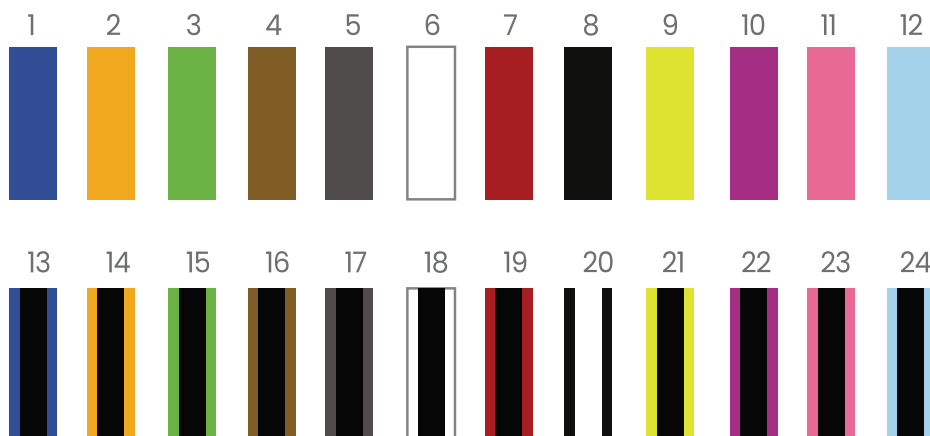

## Ordering Number

Description	Part Number Singlemode (OS2)	Price	Part Number Multimode (OM3)	Price	Part Number Multimode (OM4)	Price
Fiber Optic Indoor Cable 6 Core, LSZH	LMZ-OS2ID06	<b>30.-</b>	LMZ-OM3ID06	<b>Call</b>	LMZ-OM4ID06	<b>95.-</b>
Fiber Optic Indoor Cable 12 Core, LSZH	LMZ-OS2ID12	<b>45.-</b>	LMZ-OM3ID12	<b>Call</b>	LMZ-OM4ID12	<b>180.-</b>
Fiber Optic Indoor Cable 24 Core, LSZH	LMZ-OS2ID24	<b>70.-</b>	LMZ-OM3ID24	<b>Call</b>	LMZ-OM4ID24	<b>330.-</b>
Fiber Optic Indoor Cable 48 Core, LSZH	LMZ-OS2ID48	<b>120.-</b>	LMZ-OM3ID48	<b>Call</b>	LMZ-OM4ID48	<b>630.-</b>
Fiber Optic Indoor Cable 60 Core, LSZH	LMZ-OS2ID60	<b>Call</b>	LMZ-OM3ID60	<b>Call</b>	LMZ-OM4ID60	<b>Call</b>
Fiber Optic Indoor Cable 72 Core, LSZH	LMZ-OS2ID72	<b>Call</b>	LMZ-OM3ID72	<b>Call</b>	LMZ-OM4ID72	<b>Call</b>
Fiber Optic Indoor Cable 96 Core, LSZH	LMZ-OS2ID96	<b>Call</b>	LMZ-OM3ID96	<b>Call</b>	LMZ-OM4ID96	<b>Call</b>
Fiber Optic 1 core, Zipcord, 2.0 mm, LSZH	LMZ-OS2ID01	<b>Call</b>	LMZ-OM3ID01	<b>Call</b>	LMZ-OM4ID01	<b>Call</b>
Fiber Optic 2 core, Zipcord, 2.0 mm, LSZH	LMZ-OS2ID02	<b>Call</b>	LMZ-OM3ID02	<b>Call</b>	LMZ-OM4ID02	<b>Call</b>





## Fiber Optic Cable In/Out, ADSS, ARSS

### Fiber Optic Indoor/Outdoor Cable



#### In/Out Singlemode

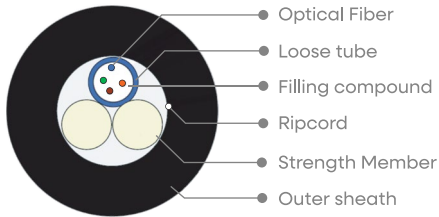

#### In/Out Multimode

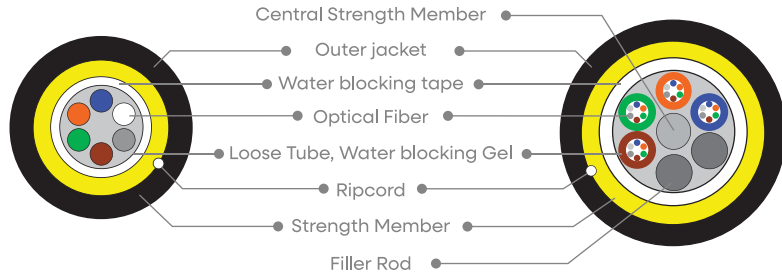

### Fiber Optic Outdoor ADSS



#### ADSS

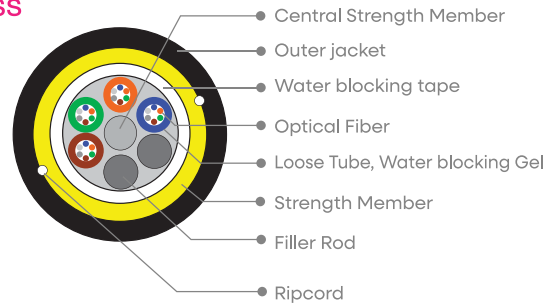

### Fiber Optic Outdoor ARSS



#### MINI ARSS Cable

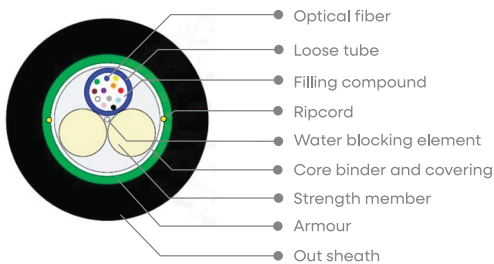

#### ARSS

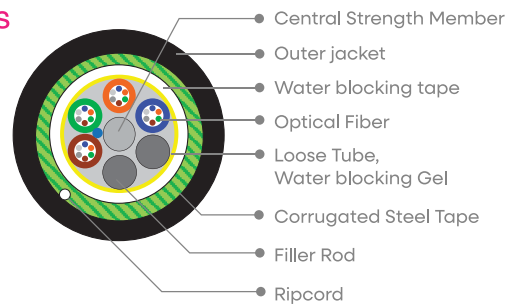

### General Specification

Product Type	Fiber Optic Duct Cable/ Fiber Optic Buried Cable, Aerial self support
Application	OSP/Indoor and Outdoor/Direct Buried/Duct
Fiber Type	Singlemode (OS2); ITU-T G.652DMultimode (OM3, OM4); ITU-T G.651
Fiber quantity	6, 12, 24, 48, 60, 72, 96 core
Cable Type	Multi-Loose Tube
Strength Member	E-Glass Yarn/Aramid Yarn
Armored Type	Corrugated Steel Tape (Outdoor Armored Cable)
Jacket Color	Black HDPE, LSZH
Operating Temp	-40°C to +70°C

## Fiber Optic Indoor/Outdoor Cable

Ordering Number						
Description	Part Number Singlemode (OS2)	Price/m	Part Number Multimode (OM3)	Price/m	Part Number Multimode (OM4)	Price/m
Fiber Optic Indoor/Outdoor Cable 6 Core, LSZH	LMZ-OS2IO06	<b>25.-</b>	LMZ-OM3IO06	<b>Call</b>	LMZ-OM4IO06	<b>115.-</b>
Fiber Optic Indoor/Outdoor Cable 12 Core, LSZH	LMZ-OS2IO12	<b>29.-</b>	LMZ-OM3IO12	<b>Call</b>	LMZ-OM4IO12	<b>190.-</b>
Fiber Optic Indoor/Outdoor Cable 24 Core, LSZH	LMZ-OS2IO24	<b>35.-</b>	LMZ-OM3IO24	<b>Call</b>	LMZ-OM4IO24	<b>340.-</b>
Fiber Optic Indoor/Outdoor Cable 48 Core, LSZH	LMZ-OS2IO48	<b>50.-</b>	LMZ-OM3IO48	<b>Call</b>	LMZ-OM4IO48	<b>620.-</b>
Fiber Optic Indoor/Outdoor Cable 60 Core, LSZH	LMZ-OS2IO60	<b>Call</b>	LMZ-OM3IO60	<b>Call</b>	LMZ-OM4IO60	<b>Call</b>
Fiber Optic Indoor/Outdoor Cable 72 Core, LSZH	LMZ-OS2IO72	<b>Call</b>	LMZ-OM3IO72	<b>Call</b>	LMZ-OM4IO72	<b>Call</b>
Fiber Optic Indoor/Outdoor Cable 96 Core, LSZH	LMZ-OS2IO96	<b>Call</b>	LMZ-OM3IO96	<b>Call</b>	LMZ-OM4IO96	<b>Call</b>

## Fiber Optic Outdoor ADSS Cable

Ordering Number		
Description	Part Number ADSS Singlemode (OS2)	Price/m
Fiber Optic Outdoor ADSS Cable 6 Core	LMZ-OS2SP06	<b>26.-</b>
Fiber Optic Outdoor ADSS Cable 12 Core	LMZ-OS2SP12	<b>30.-</b>
Fiber Optic Outdoor ADSS Cable 24 Core	LMZ-OS2SP24	<b>38.-</b>
Fiber Optic Outdoor ADSS Cable 48 Core	LMZ-OS2SP48	<b>55.-</b>
Fiber Optic Outdoor ADSS Cable 60 Core	LMZ-OS2SP60	<b>Call</b>
Fiber Optic Outdoor ADSS Cable 72 Core	LMZ-OS2SP72	<b>Call</b>
Fiber Optic Outdoor ADSS Cable 96 Core	LMZ-OS2SP96	<b>Call</b>

## Fiber Optic Outdoor ARSS Cable

Ordering Number				
Description	Part Number ARSS Singlemode (OS2)	Price/m	Part Number Mini ARSS Singlemode (OS2)	Price/m
Fiber Optic Outdoor ARSS Cable 6 Core	LMZ-OS2SAP06	<b>35.-</b>	LMZ-OS2MR06	<b>22.-</b>
Fiber Optic Outdoor ARSS Cable 12 Core	LMZ-OS2SAP12	<b>40.-</b>	LMZ-OS2MR12	<b>26.-</b>
Fiber Optic Outdoor ARSS Cable 24 Core	LMZ-OS2SAP24	<b>55.-</b>	LMZ-OS2MR24	<b>32.-</b>
Fiber Optic Outdoor ARSS Cable 48 Core	LMZ-OS2SAP48	<b>70.-</b>		
Fiber Optic Outdoor ARSS Cable 60 Core	LMZ-OS2SAP60	<b>Call</b>		
Fiber Optic Outdoor ARSS Cable 72 Core	LMZ-OS2SAP72	<b>Call</b>		
Fiber Optic Outdoor ARSS Cable 96 Core	LMZ-OS2SAP96	<b>Call</b>		

# Fiber Optic Patch Panel

## HD Patch Panel & Accessories

 New Series

● HD Patch Panel

- ▶ เพิ่มความลึกของภาต
- ▶ เพิ่มความหนาของเหล็ก



LMZ-FPR14S

● Front Cable Management



LMZ-FPRA01



LMZ-FPRA02

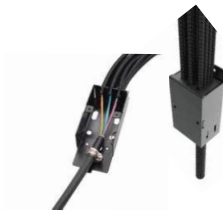

LMZ-FPRA03



LMZ-SP01

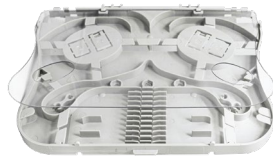

LMZ-SP02



LMZ-SLEEVE-60



### General Specification

Product Type	Fiber Optic Rack Mount Sliding Panel
Application	Accept 4 HD Adapter Plate/ HD MPO Cassette
Cable Entries	6
Fiber Capacity	Max. 96F in LC Connector
Rack Unit	1
Material	Cold Rolled Steel with Powder Coating
Operating Temp	-5°C to +50°C

## Wall Mount



**LMZ-FPW01**



**LMZ-FPW02**



**LMZ-FPW04**



### General Specification

Product Type	Fiber Optic Wall Mount
Application	Accept 1, 2, 4 HD Adapter Plate
Fiber Capacity	Max. 96F in LC Connector
Material	Cold Rolled Steel with Powder Coating
Operating Temp	-5°C to +50°C

### Ordering Number

Part Number	Description	Price
LMZ-FPR14S	HD Fiber Optic Sliding Patch Panel 4 Snap-in, 1U	<b>2,600.-</b>
LMZ-FPRA01	Front Cable Management For LMZ-FPR14S	<b>1,400.-</b>
LMZ-FPRA02	Fiber Management Spool	<b>Call</b>
LMZ-FPRA03	Transition Breakout	<b>Call</b>
LMZ-FPW01	Wall Mount Enclosure, 1 HD Snap-in	<b>1,900.-</b>
LMZ-FPW02	Wall Mount Enclosure, 2 HD Snap-in	<b>2,100.-</b>
LMZ-FPW04	Wall Mount Enclosure, 4 HD Snap-in	<b>5,000.-</b>
LMZ-SP01	Splice Tray Support, 24F (Black)	<b>250.-</b>
LMZ-SP02	Splice Tray Support, 24F (Grey)	<b>250.-</b>
LMZ-SLEEVE-60	Limaz Fiber Optic Sleeve, 60 mm ( 100 Pcs/Pack)	<b>300.-</b>

# Fiber Optic Patch Panel

## HD Adapter Plate, MPO Cassette



LMZ-F1AP06DLC-MM



LMZ-F1AP06QLC-MM



LMZ-F1AP06DSC-MM



LMZ-F1AP06DLC-SM



LMZ-F1AP06QLC-SM



LMZ-F1AP06DSC-SM



LMZ-F1AP06DLC-SA



LMZ-F1AP06QLC-SA



LMZ-F1AP06DSC-SA



LMZ-F1AP00

## Universal Polarity A,B,C



LMZ-F1MZ06QLCA-MM



LMZ-F1MZ06QLCA-SM



LMZ-F1MZ06QLCA-SA



## General Specification

Product Type	HD Adapter Plate & HD MPO Cassette Application
Sleeve Material	Ceramic
Fiber Mode	Singlemode, Multimode
Connector Type	SC Duplex, LC Duplex, LC Quad, MPO
Quantity, front	6, 12, 24 F
Operating Temp.	-5°C to +50°C

## Ordering Number

Part Number	Description	Price
LMZ-F1AP03DSC-MM	HD Adapter Plate 3 SC Duplex, Multimode 6F AQ	<b>Call</b>
LMZ-F1AP03DSC-SM	HD Adapter Plate 3 SC Duplex, Singlemode 6F Blue	<b>Call</b>
LMZ-F1AP06QLC-SM	HD Adapter Plate 6 LC Quad, Singlemode, 24F, Blue	<b>500.-</b>
LMZ-F1AP06QLC-SA	HD Adapter Plate 6 LC/APC Quad, Singlemode, 24F, Green	<b>500.-</b>
LMZ-F1AP06QLC-MM	HD Adapter Plate 6 LC Quad, Multimode, 24F, AQ	<b>500.-</b>
LMZ-F1AP06DLC-SM	HD Adapter Plate 6 LC Duplex, Singlemode, 12F, Blue	<b>350.-</b>
LMZ-F1AP06DLC-SA	HD Adapter Plate 6 LC/APC Duplex, Singlemode, 12F, Green	<b>350.-</b>
LMZ-F1AP06DLC-MM	HD Adapter Plate 6 LC Duplex, Multimode, 12F, AQ	<b>350.-</b>
LMZ-F1AP06DSC-SM	HD Adapter Plate 6 SC Duplex, Singlemode 12F Blue	<b>350.-</b>
LMZ-F1AP06DSC-SA	HD Adapter Plate 6 SC/APC Duplex, Singlemode, 12F, Green	<b>350.-</b>
LMZ-F1AP06DSC-MM	HD Adapter Plate 6 SC Duplex, Multimode 12F AQ	<b>350.-</b>
LMZ-F1M06M-UD	Adapter Plate, 6 MPO Port ( Up To Down )	<b>5,250.-</b>
LMZ-F1M12M-UD	Adapter Plate, 12 MPO Port ( Up To Down )	<b>7,800.-</b>
LMZ-F1AP00	HD Blank Adapter Plate	<b>90.-</b>
LMZ-F1MYA06QLCB-SM	HD Cassette 2 x MPO ( 12 Core ) APC Male to 24 LC/UPS Singlemode, Type B	<b>11,500.-</b>
LMZ-F1MYA06QLCB-SA	HD Cassette 2 x MPO ( 12 Core ) APC Male to 24 LC/APC Singlemode, Type B	<b>11,650</b>
LMZ-F1MY06QLCB-MM	HD Cassette 2 x MPO ( 12 Core ) Male to 24 Multimode OM4, Type B	<b>10,300.-</b>
LMZ-F1MZ06QL-MM	HD Cassette 1 x MPO ( 24 Core ) APC Male to 24 LC/UPC Singlemode, Type B	<b>9,850.-</b>
LMZ-F1MZ06QL-SM	HD Cassette 1 x MPO ( 24 Core ) APC Male to 24 LC/APC Singlemode, Type B	<b>10,800.-</b>
LMZ-F1MZ06QL-SA	HD Cassette 1 x MPO ( 24 Core ) Male to 24 LC Multimode OM4, Type B	<b>11,000.-</b>
LMZ-F1MZA06QLCB-SM	HD Cassette 1 x MPO ( 12 Core ) APC Male to 12 LC/UPS Singlemode, Type B	<b>10,800.-</b>
LMZ-F1MZA06QLCB-SA	HD Module MP0-24/Male - 6 LC Quad, Multimode, 24F, AQ	<b>11,000.-</b>
LMZ-F1MZ06QLCB-MM	HD Module MP0-24/Male - 6 LC Quad, Singlemode, 24F, Blue	<b>9,850.-</b>
LMZ-F1MYA06DLCB-SM	HD Module MP0-24/Male - 6 LC/APC Quad, Singlemode, 24F, Green	<b>6,250.-</b>
LMZ-F1MYA06DLCB-SA	HD Cassette 1 x MPO ( 12 Core ) APC Male to 12 LC/APC Singlemode, Type B	<b>6,350.-</b>
LMZ-F1MYA06DLCB-MM	HD Cassette 1 x MPO ( 12 Core ) Male to 12 LC Multimode OM4, Type B	<b>5,750.-</b>

# Fiber Optic Patch Panel

## UHD Patch Panel Data Center

LIMAZ UHD Series คือภาคไฟเบอร์รองรับความเร็วสูงแบบครบวงจรจาก LIMAZ ที่มาพร้อมกับ Modular Ultra high-density fiber panels ใน 1 ยูนิตสามารถรองรับไฟเบอร์ได้หลาย Core ประหยัดพื้นที่การใช้งาน, Modules, Cassettes และ Adapters

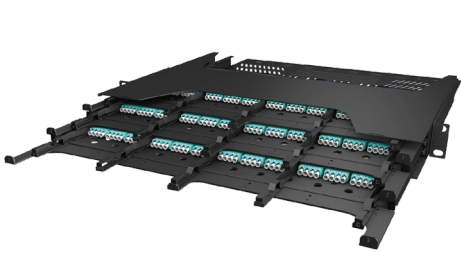

**LMZ-FPR112S**  
1U Max 144 Core



**LMZ-FPR224S**  
2U Max 288 Core



**LMZ-FPR448S**  
4U Max 576 Core



### General Specification

Product Type	Fiber Optic Rack Mount Panel
Application	Accept UHD Adapter Tray/ UHD MPO Tray
Fiber Capacity	1U: 144LC, 2U: 288LC, 4U: 576LC
Rack Unit	1U/2U/4U*483*350 mm (Exclude back tray)
Material	Steel
Operating Temp	-25°C to +75°C

### Ordering Number

Part Number	Description	Price
LMZ-FPR112S	UHD F.O. Patch Panel 12 Snap-in, Sliding Type, 1U	<b>18,500.-</b>
LMZ-FPR224S	UHD F.O. Patch Panel 24 Snap-in, Sliding Type, 2U	<b>39,000.-</b>
LMZ-FPR448S	UHD F.O. Patch Panel 48 Snap-in, Sliding Type, 4U	<b>74,000.-</b>

## UHD Adapter Tray



**LMZ-F2MY06DLCB-MM**



**LMZ-F2MY04DLCB-MM**

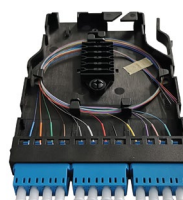

**LMZ-F2AP06DLC-SM**



**LMZ-F2MY04DLCB-SM**



### General Specification

Product Type	UHD Adapter Tray & UHD MPO Tray
Sleeve Material	Plastic
Fiber Mode	Singlemode, Multimode
Connector Type	LC/UPC Duplex, LC/APC Duplex, MPO
Quantity, front	8, 12 F
Operating Temp	-20°C to +70°C

### Ordering Number

Part Number	Description	Price
LMZ-F2UXA02QLCB-SM	UHD Cassette 1 x MPO(8 Core) APC male to 8 LC/UPC Singlemode, Type B	<b>5,700.-</b>
LMZ-F2UXA02QLCB-SA	UHD Cassette 1 x MPO(8 Core) APC male to 8 LC/APC Singlemode, Type B	<b>5,700.-</b>
LMZ-F2UX02QLCB-MM	UHD Cassette 1 x MPO(8 Core) male to 8 LC Multimode OM4, Type B	<b>4,200.-</b>
LMZ-F2UYA03QLCB-SM	UHD Cassette 1 x MPO(12 Core) APC male to 12 LC/UPC Singlemode, Type B	<b>6,200.-</b>
LMZ-F2UYA03QLCB-SA	UHD Cassette 1 x MPO(12 Core) APC male to 12 LC/APC Singlemode, Type B	<b>6,200.-</b>
LMZ-F2UY03QLCB-MM	UHD Cassette 1 x MPO(12 Core) male to 12 LC Multimode OM4, Type B	<b>4,650.-</b>
LMZ-F2UZA06QLCB-SM	UHD Cassette 2 x MPO(12 Core) APC male to 24 LC/UPC Singlemode, Type B	<b>Call</b>
LMZ-F2UZA06QLCB-SA	UHD Cassette 2 x MPO(12 Core) APC male to 24 LC/APC Singlemode, Type B	<b>Call</b>
LMZ-F2UZ06QLCB-MM	UHD Cassette 2 x MPO(12 Core) male to 24 LC Multimode OM4, Type B	<b>Call</b>
LMZ-F2AP06QLCP-SM	UHD Cassette 1 x MPO(24 Core) APC male to 24 LC/UPC Singlemode, Type B	<b>Call</b>
LMZ-F2AP06QLCP-SA	UHD Cassette 1 x MPO(24 Core) APC male to 24 LC/APC Singlemode, Type B	<b>Call</b>
LMZ-F2AP06QLCP-MM	UHD Cassette 1 x MPO(24 Core) male to 24 LC Multimode OM4, Type B	<b>Call</b>
LMZ-F2AP03QLCP-SM	UHD Cassette 12 LC/UPC Singlemode with 12 x LC Pigtail	<b>2,000.-</b>
LMZ-F2AP03QLCP-SA	UHD Cassette 12 LC/APC Singlemode with 12 x LC Pigtail	<b>2,000.-</b>
LMZ-F2AP03QLCP-MM	UHD Cassette 12 LC Multimode OM4 with 12 x LC Pigtail	<b>2,000.-</b>
LMZ-F2U03DLC	UHD Cassette 6 MPO port (up to down)	<b>3,900.-</b>
LMZ-F2AP00-12	Blank panel for 12 LC	<b>650.-</b>
LMZ-F2AP00-08	Blank panel for 8 LC	<b>550.-</b>



## Fiber Optic Cable Assembly

### Patch Cord & Pigtail



Patch Cord LC UPC to LC UPC  
Duplex OS2 Singlemode



Patch Cord LC UPC to SC UPC  
Duplex OS2 Singlemode



Patch Cord SC UPC to SC UPC  
Duplex OM3/OM4 Multimode



#### General Specification

Product Type	Fiber Optic Patch Cord/Fiber Optic Pigtail
Fiber Type	Singlemode (OS2) / Multimode (OM3, OM4)
Connector A	SC, LC (UPC, APC)
Connector B	SC, LC (UPC, APC), Open End for Pigtail
Fiber, Quantity	2; Patch Cord Duplex / 1; Pigtail, Simplex
Jacket Diameter	900 μm, 2.0 mm, 3.0mm
Flammability Rating	LSZH
Operating Temp	-20°C to +60°C



LC UPC Simplex OS2  
Singlemode



UPC Simplex OS2  
Singlemode



LC UPC Simplex  
OM3/OM4 Multimode



SC UPC Simplex  
OM3/OM4 Multimode

#### Ordering Number

Part Number	Description	Price : (1m.)	(2m.)	(3m.)	(5m.)	(10m.)	(Add1m.)
LMZ-LCLCOS2DYL(XX)	Fiber Optic Patch Cord Singlemode LC-LC Duplex LSZH	200.-	220.-	250.-	300.-	350.-	10.-
LMZ-LCALCAOS2DYL(XX)	Fiber Optic Patch Cord Singlemode LC/APC-LC/APC Duplex LSZH	220.-	240.-	270.-	330.-	380.-	12.-
LMZ-LCLCOM3DAQ(XX)	Fiber Optic Patch Cord Multimode OM3 LC-LC Duplex LSZH	230.-	270.-	330.-	450.-	550.-	25.-
LMZ-LCLCOM4DAQ(XX)	Fiber Optic Patch Cord Multimode OM4 LC-LC Duplex LSZH	240.-	300.-	350.-	520.-	680.-	30.-
LMZ-LCLCOS2D5YL(XX)	Fiber Optic Patch Cord Singlemode Uniboot Switchable Pull Tap LC-LC Duplex LSZH	410.-	430.-	460.-	550.-	600.-	10.-
LMZ-LCLCOM3D5AQ(XX)	Fiber Optic Patch Cord Singlemode Uniboot Switchable Pull Tap LC/APC-LC/APC Duplex LSZH	420.-	450.-	480.-	590.-	650.-	12.-
LMZ-LCLCOM4D5AQ(XX)	Fiber Optic Patch Cord Multimode OM4 Uniboot Switchable Pull Tap LC/APC-LC/APC Duplex LSZH	470.-	550.-	630.-	850.-	1,100.-	30.-
LMZ-SCLCOS2DYL(XX)	Fiber Optic Patch Cord Singlemode SC-LC Duplex LSZH	230.-	250.-	280.-	320.-	360.-	10.-
LMZ-SCALCAOS2DYL(XX)	Fiber Optic Patch Cord Singlemode SC/APC-LC/APC Duplex LSZH	250.-	270.-	300.-	350.-	400.-	12.-
LMZ-SCLCOM3DAQ(XX)	Fiber Optic Patch Cord Multimode OM3 SC-LC Duplex LSZH	260.-	300.-	350.-	450.-	550.-	25.-
LMZ-SCLCOM4DAQ(XX)	Fiber Optic Patch Cord Multimode OM4 SC-LC Duplex LSZH	270.-	330.-	400.-	550.-	700.-	30.-
LMZ-SCSCOS2DYL(XX)	Fiber Optic Patch Cord Singlemode SC-SC Duplex LSZH	230.-	250.-	280.-	320.-	360.-	10.-
LMZ-SCASCAOS2DYL(XX)	Fiber Optic Patch Cord Singlemode SC/APC-SC/APC Duplex LSZH	250.-	270.-	300.-	350.-	400.-	12.-
LMZ-SCSCOM3DAQ(XX)	Fiber Optic Patch Cord Multimode OM3 SC-SC Duplex LSZH	260.-	300.-	350.-	450.-	550.-	25.-
LMZ-SCSCOM4DAQ(XX)	Fiber Optic Patch Cord Multimode OM4 SC-SC Duplex LSZH	270.-	330.-	400.-	550.-	700.-	30.-

#### Ordering Number

#### Pigtail (12 Pcs/Pack)

Part Number	Description	Price
LMZ-LCUCOS-YLM(XX)-PK	Pigtail LC/UPC for Singlemode (12pcs/pack)	600.-
LMZ-LCACOS-YLM(XX)-PK	Pigtail LC/APC for Singlemode (12pcs/pack)	650.-
LMZ-LCUCOM4-AQM(XX)-PK	Pigtail LC/UPC for Multimode OM4 (12pcs/pack)	800.-
LMZ-SCUCOS-YLM(XX)-PK	Pigtail SC/UPC for Singlemode (12pcs/pack)	600.-
LMZ-SCACOS-YLM(XX)-PK	Pigtail SC/APC for Singlemode (12pcs/pack)	650.-
LMZ-SCUCOM4-AQM(XX)-PK	Pigtail SC/UPC for Multimode OM4 (12pcs/pack)	800.-

Length (xx) : 01 ( 1m. ), 02 ( 2m. ), 03 ( 3m. ), ...

# MPO Cable



LMZ-ITFF4Y12BLXX

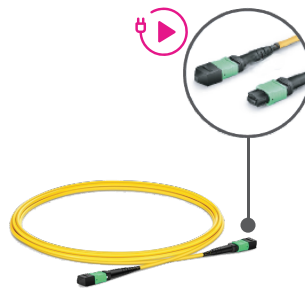

LMZ-ITFFSY12BLXX

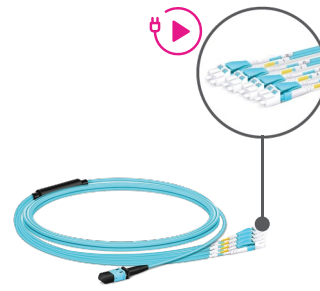

LMZ-ITFLSY12BL(XX)-(YY)

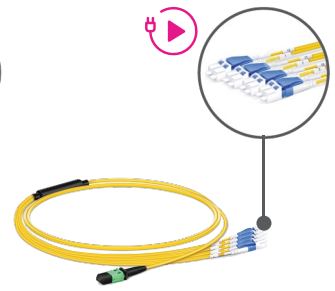

LMZ-ITFL4Y12BL(XX)-(YY)



## General Specification

Product Type	MPO Trunk Cable/ MPO Array Cord/ MPO Fan Out
Fiber Type	Singlemode (OS2) Multimode (OM3, OM4)
Connector A	MPO-8, MPO-12, MPO-24
Connector B	MPO-8, MPO-12, MPO-24, LC Duplex
Connector Type	Male (Pinned), Female (Unpinned)
Fiber, Quantity	8, 12, 24
Flammability Rating	LSZH
Operating Temp	-20°C to +60°C

## Ordering Number

Part Number	Description	Price : (5m.)	(10m.)	(20m.)	(50m.)
LMZ-ITFAFASX08BL(XX)	Trunk Cable MPO8F/APC/female-MPO8F/APC/female, Singlemode LSZH Yellow TypeB	1,400.-	1,500.-	1,700.-	2,300.-
LMZ-ITFFSX08BL(XX)	Trunk Cable MPO8F/UPC/female-MPO8F/UPC/female, Singlemode LSZH Yellow TypeB	1,400.-	1,500.-	1,700.-	2,300.-
LMZ-ITFF4X08BL(XX)	Trunk Cable MPO8F/UPC/female-MPO8F/UPC/female, Multimode OM4 Aqua TypeB	1,700.-	2,250.-	3,500.-	7,000.-
LMZ-ITFAFASY12BL(XX)	Trunk Cable MPO12F/APC/female-MPO12F/APC/female, Singlemode LSZH Yellow TypeB	1,400.-	1,550.-	1,800.-	2,500.-
LMZ-ITFFSY12BL(XX)	Trunk Cable MPO12F/UPC/female-MPO12F/UPC/female, Singlemode LSZH Yellow TypeB	1,400.-	1,550.-	1,800.-	2,500.-
LMZ-ITFF4Y12BL(XX)	Trunk Cable MPO12F/UPC/female-MPO12F/UPC/female, Multimode OM4 Aqua TypeB	1,850.-	2,700.-	4,400.-	9,500.-
LMZ-ITFAFASZ24BL(XX)	Trunk Cable MPO24F/APC/female-MPO24F/APC/female, Singlemode LSZH Yellow TypeB	3,550.-	3,750.-	4,200.-	5,500.-
LMZ-ITFFSZ24BL(XX)	Trunk Cable MPO24F/UPC/female-MPO24F/UPC/female, Singlemode LSZH Yellow TypeB	3,550.-	3,750.-	4,200.-	5,500.-
LMZ-ITFF4Z24BL(XX)	Trunk Cable MPO24F/UPC/female-MPO24F/UPC/female, Multimode OM4 Aqua TypeB	4,400.-	6,000.-	9,350.-	19,250.-
LMZ-ITFAFASY24BL(XX)	Trunk Cable 2xMPO12F/APC/female-2xMPO12F/APC/female, Singlemode LSZH Yellow TypeB	3,950.-	4,150.-	5,550.-	5,750.-
LMZ-ITFFSY24BL(XX)	Trunk Cable 2xMPO12F/UPC/female-2xMPO12F/UPC/female, Singlemode LSZH Yellow TypeB	3,950.-	4,150.-	5,550.-	5,750.-
LMZ-ITFF4Y24BL(XX)	Trunk Cable 2xMPO12F/UPC/female-2xMPO12F/UPC/female, Multimode OM4 Aqua TypeB	4,900.-	6,550.-	9,850.-	19,750.-
LMZ-ITFALSZY12BL(XX)-(YY)	Trunk Cable MPO12F/APC/female-6LC/APC Duplex, Singlemode LSZH Yellow TypeB	1,850.-	1,950.-	2,150.-	2,800.-
LMZ-ITFLSY12BL(XX)-(YY)	Trunk Cable MPO12F/UPC/female-6LC/UPC Duplex, Singlemode LSZH Yellow TypeB	1,850.-	1,950.-	2,150.-	2,800.-
LMZ-ITFL4Y12BL(XX)-(YY)	Trunk Cable MPO12F/UPC/female-6LC/UPC Duplex, Multimode OM4 Aqua TypeB	2,450.-	3,300.-	5,000.-	10,000.-
LMZ-ITFALSZ24BL(XX)-(YY)	Trunk Cable MPO24F/APC/female-12LC/APC Duplex, Singlemode LSZH Yellow TypeB	3,950.-	4,150.-	4,550.-	5,750.-
LMZ-ITFLSZ24BL(XX)-(YY)	Trunk Cable MPO24F/UPC/female-12LC/UPC Duplex, Singlemode LSZH Yellow TypeB	3,950.-	4,150.-	4,550.-	5,750.-
LMZ-ITFL4Z24BL(XX)-(YY)	Trunk Cable MPO24F/UPC/female-12LC/UPC Duplex, Multimode OM4 Aqua TypeB	5,200.-	6,850.-	10,150.-	20,000.-

**Type :** A =Type A, B =Type B, C= Type C

**Length (XX) :** 01 ( 1m. ), 02 ( 2m. ), 03 ( 3m. ), ...

**Length Fan out Cable (YY) :** 01 ( 1m. ), 02 ( 2m. ), 03 ( 3m. ), ...

# Optical Module

## SFP Module, SFP Bidi Module



LMZ-M01L



LMZ-M01M



LMZ-M01M-02



LMZ-M01S-20



LMZ-M01S-02T



LMZ-M01S-02R



LMZ-M01M-02T



LMZ-M01M-02R



### General Specification

Product Type	SFP Module, SFP Bidi Module
Application	Operating Data Rate up to 1.25 Gbps.
Connector Type	LC Duplex, Simplex, RJ45 Modular Plug
Cable Type	Singlemode (OS2), Multimode (OM3, OM4)
Power Supply Voltage	3.3 V
Power Supply Current	300 mA
Operating Humidity	5 to 85 %
Operating Temp	0°C to +70°C

### Ordering Number : Copper SFP

Part Number	Description	Price : CISCO	HP Aruba
LMZ-M01L	LIMAZ 10/100/1000 Mbps, 100 M.	2,300.-	2,300.-
LMZ-M10C-0.03-CI	Limaz 10GBASE-T Copper SFP Module Copper RJ-45 30m, Copper, compatible with Cisco / HP switch	6,650.-	6,650.-

### Ordering Number : SFP Module, SFP Bidi Module 1.25 G

Part Number	Description	Price : CISCO	HP Aruba
LMZ-M01M	LIMAZ SFP 1.25G, Multimode, 550 m.	880.-	880.-
LMZ-M01M-02	LIMAZ SFP 1.25G, Multimode, 2 km	950.-	950.-
LMZ-M01S-20	LIMAZ SFP 1.25G, Singlemode, LC, 20km	880.-	880.-
LMZ-M01S-40	LIMAZ SFP 1.25G, Singlemode, LC, 40km	1800.-	1800.-
LMZ-M01S-80	LIMAZ SFP 1.25G, Singlemode, LC, 80km	3200.-	3200.-
LMZ-M01S-120	LIMAZ SFP 1.25G, Singlemode, LC, 120km	4600.-	4600.-
LMZ-M01S-02-T	LIMAZ BIDI SFP 1.25G, Singlemode, 2 km [Type A]	1000.-	1000.-
LMZ-M01S-02-R	LIMAZ BIDI SFP 1.25G, Singlemode, 2 km [Type B]	1000.-	1000.-
LMZ-M01S-10-T	LIMAZ BIDI SFP 1.25G, Singlemode, 10 km [Type A]	900.-	900.-
LMZ-M01S-10-R	LIMAZ BIDI SFP 1.25G, Singlemode, 10 km [Type B]	900.-	900.-
LMZ-M01S-20-T	LIMAZ BIDI SFP 1.25G, Singlemode, 20 km [Type A]	1150.-	1150.-
LMZ-M01S-20-R	LIMAZ BIDI SFP 1.25G, Singlemode, 20 km [Type B]	1150.-	1150.-
LMZ-M01S-40-T	LIMAZ BIDI SFP 1.25G, Singlemode, 40 km [Type A]	1800.-	1800.-
LMZ-M01S-40-R	LIMAZ BIDI SFP 1.25G, Singlemode, 40 km [Type B]	1800.-	1800.-

## SFP+ Module



**LMZ-M10M**



**LMZ-M10S-10**



### General Specification

Product Type	SFP+ Module
Application	Operating Data Rate up to 10.31 Gbps.
Connector Type	LC Duplex
Cable Type	Singlemode (OS2), Multimode (OM3, OM4)
Power Supply Voltage	3.3 V
Power Supply Current	300 mA
Operating Humidity	5 to 85 %
Operating Temp	0°C to +70°C

### Ordering Number : SFP+ Module 10 G

Part Number	Description	Price : CISCO	HP Aruba
LMZ-M10M	Limaz SFP+ 10G, Multimode, 300 m.	<b>1,200.-</b>	<b>1,200.-</b>
LMZ-M10S-10	Limaz SFP+ 10G, Singlemode, 10 km.	<b>2,500.-</b>	<b>2,500.-</b>
LMZ-M10S-20	Limaz SFP+ 10G, Singlemode, 20 km.	<b>2,700.-</b>	<b>2,700.-</b>
LMZ-M10S-40	Limaz SFP+ 10G, Singlemode, 40 km.	<b>12,000.-</b>	<b>12,000.-</b>
LMZ-M10S-80	Limaz SFP+ 10G, Singlemode, 80 km.	<b>22,000.-</b>	<b>22,000.-</b>

## QSFP+ Module



**LMZ-M40M-10**



**LMZ-M40S-10**



### General Specification

Product Type	QSFP+ Module
Application	Operating Data Rate up to 41.25 Gbps.
Connector Type	MPO
Cable Type	Singlemode (OS2), Multimode (OM3, OM4)
Power Supply Voltage	3.3 V
Power Supply Current	300 mA
Operating Humidity	5 to 85 %
Operating Temp.	0°C to +70°C

### Ordering Number : QSFP+ Module 40 G

Part Number	Description	Price : CISCO	HP Aruba
LMZ-M40M-10	LIMAZ QSFP+ 40G, Multimode, 150 m.	<b>9,000.-</b>	<b>9,000.-</b>
LMZ-M40S-10	LIMAZ QSFP+ 40G, Singlemode, 10 km.	<b>29,000.-</b>	<b>29,000.-</b>
LMZ-M40S-40	LIMAZ QSFP+ 40G, Singlemode, 40 km.	<b>85,000.-</b>	<b>85,000.-</b>

## FTTX

### FTTX Cable

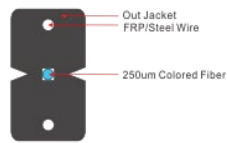

**FTTH Flat Cable**

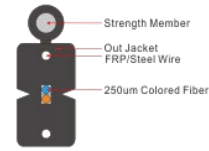

**FTTH Self-Support Flat Drop Cable**

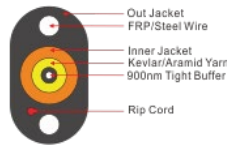

**FTTP Tight Buffered Cable**



**FTTH Round Self-Support Cable**



### General Specification

Product Type	FTTH Flat Cable /FTTH Self-Support Flat Drop Cable/ FTTP Tight Buffered Cable / FTTH Round Self-Support Cable
Application	FTTH Solution
Construction Type	Non-armored
Fiber Type	Singlemode ; ITU-T G.652D, ITU-T G.6527A2, ITUT G.657A1
Fiber quantity	1, 2, 4 core
Strength Member	FRP (Fiber Reinforced Plastic)
Jacket Color	Black LSZH, HDPE
Operating Temp	-20°C to +60°C

### Ordering Number

Part Number	Description	Price ( 1 Km. )
LMZ-OS2HFS01-L	LIMAZ FTTH Indoor/Outdoor Flat Cable 1 Core, Singlemode, G. 657A2, LSZH	<b>5,200.-</b>
LMZ-OS2HFS02-L	LIMAZ FTTH Indoor/Outdoor Flat Cable 2 Core, Singlemode, G. 657A2, LSZH	<b>7150.-</b>
LMZ-OS2HFS04-L	LIMAZ FTTH Indoor/Outdoor Flat Cable 4 Core, Singlemode, G. 657A2, LSZH	<b>11,200.-</b>
LMZ-OS2HFS01	LIMAZ FTTH Outdoor Flat Cable 1 Core, Singlemode, G. 657A2, HDPE	<b>5,200.-</b>
LMZ-OS2HFS02	LIMAZ FTTH Outdoor Flat Cable 2 Core, Singlemode, G. 657A2, HDPE	<b>7,150.-</b>
LMZ-OS2HFS04	LIMAZ FTTH Outdoor Flat Cable 4 Core, Singlemode, G. 657A2, HDPE	<b>11,200.-</b>
LMZ-OS2HRS01	LIMAZ FTTH Outdoor Round Self Support Outdoor Cable 1 Core,Singlemode G. 657A2, HDPE	<b>Call</b>
LMZ-OS2HRS02	LIMAZ FTTH Outdoor Round Self Support Outdoor Cable 2 Core,Singlemode G. 657A2, HDPE	<b>Call</b>
LMZ-OS2HRS04	LIMAZ FTTH Outdoor Round Self Support Outdoor Cable 4 Core,Singlemode G. 657A2, HDPE	<b>Call</b>

## Fast Installed Connector



**SC/APC**



**SC/UPC**



**LC/UPC**



### General Specification

Product Type	Fast Installed Connector
Support	Singlemode, Multimode
Insert loss	0.3 dB
Return loss	55 dB (UPC), 65 dB (APC)
Fastening strength of naked fiber	5 N
Fastening strength of naked fiber holder	10 N
Tensile strength	50 N
Operating Temp	-40°C to 75°C
Durability	500 Times

### Ordering Number

Part Number	Description	Price
LMZ-FFSC-SM	LIMAZ SC/UPC Fast Connector, Singlemode	<b>58.-</b>
LMZ-FFSC-SA	LIMAZ SC/APC Fast Connector, Singlemode	<b>90.-</b>
LMZ-FFSC-MM	LIMAZ SC/UPC Fast Connector, Multimode	<b>Call</b>
LMZ-FFLC-SM	LIMAZ LC/UPC Fast Connector, Singlemode	<b>230.-</b>
LMZ-FFLC-SA	LIMAZ LC/APC Fast Connector, Singlemode	<b>300.-</b>
LMZ-FFLC-MM	LIMAZ LC/UPC Fast Connector, Multimode	<b>Call</b>

## FTTX

### Wall Outlet & PLC Splitter

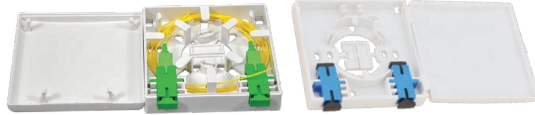
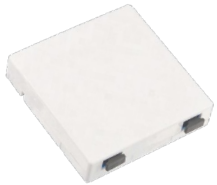

Wall Outlet

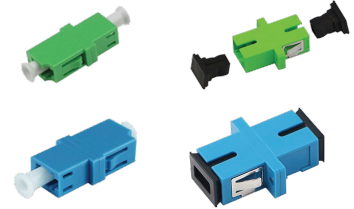

SC, LC Adapters

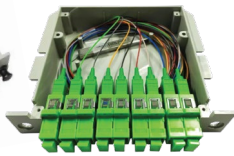

Cassette



ABS Box

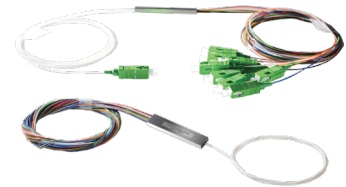

Compact



#### General Specification

Product Type	FTTX Wall Outlet & PLC Splitter
Application	SC, LC
Support	Singlemode
Material	ABS plastic
Operating Temp	-20°C to +75°C

#### Ordering Number

Part Number	Description	Price
LMZ-FSB104-SA	LIMAZ Fiber Optic Splitter 1x4 SC/APC, Singlemode, ABS Box	780.-
LMZ-FSB108-SA	LIMAZ Fiber Optic Splitter 1x8 SC/APC, Singlemode, ABS Box	850.-
LMZ-FSC104-SA	LIMAZ Fiber Optic Splitter 1x4 SC/APC, Singlemode, Compact	540.-
LMZ-FSC108-SA	LIMAZ Fiber Optic Splitter 1x8 SC/APC, Singlemode, Compact	760.-
LMZ-FSL104-SA	LIMAZ Fiber Optic Splitter 1x4 SC/APC, Singlemode, LGX Cassette	630.-
LMZ-FSL108-SA	LIMAZ Fiber Optic Splitter 1x8 SC/APC, Singlemode, LGX Cassette	740.-
LMZ-FOW12	LIMAZ FTTH Wall Outlet 2 Port, Standard Type [SC Simplex, LC Duplex]	75.-
LMZ-FADSSC-SM	LIMAZ SC/UPC Simplex Adapter, Singlemode, Blue	40.-
LMZ-FADSSC-SA	LIMAZ SC/APC Simplex Adapter, Singlemode, Green	40.-

## Termination Box



### General Specification

Product Type	FTTX Termination Box
Application	Indoor, Outdoor, Indoor/Outdoor
Adaptor suitable type	SC, LC, FC, ST
Type	12-48 port
Material	Cold Rolled Steel / PC + ABS
Level of Protection	IP65
Working Temperature	-40°C to +85°C
Humidity	≤85%(+30°C)

### Ordering Number

Part Number	Description	Price
LMZ-FTBA12	LIMAZ Fiber Optic Termination Box, Indoor type, 12 Fiber	<b>Call</b>
LMZ-FTBA24	LIMAZ Fiber Optic Termination Box, Indoor type, 24 Fiber	<b>Call</b>
LMZ-FTBB12	LIMAZ Fiber Optic Termination Box, Outdoor type, 12 Fiber	<b>2,400.-</b>
LMZ-FTBB24	LIMAZ Fiber Optic Termination Box, Outdoor type, 24 Fiber	<b>3,300.-</b>
LMZ-FOTB12	LIMAZ Fiber Optic Termination Box, Indoor/Outdoor type, 12 Fiber	<b>970.-</b>
LMZ-FOTB24	LIMAZ Fiber Optic Termination Box, Indoor/Outdoor type, 24 Fiber	<b>1,200.-</b>



# PureWhite

S E R I E S



NEW ARRIVALS

# Pure White Series

## LC | LIMAZ Cabinet



### General Specification

- Cabinet solution adaptable to server, network, data center or mixed-use application.
- Perforated doors for massive front-to-rear airflow up to 80%.
- Static loading capacity up to 1,500 kg. (without levelling feet and castors).
- Universal, 19" W, vertical hole spacing complies with EIA-310E (3 holes)
- Solutions are available for traditional hot aisle/cold aisle environments and containment.
- Modular knock down can be shipped in build-up or flat-packed (saving 60% space).
- Swing handle latch with 3 digits keyed lock.



### Details



A ประตูบานเดี่ยวแบบรูพรุนที่สามารถระบายอากาศได้มากถึง 80% ได้รับการออกแบบใหม่ในรูปแบบลูกคลื่น



B ประตูด้านหลังเป็นแบบบานคู่ เพื่อลดพื้นที่ในการเข้าจัดการอุปกรณ์จากทางด้านหลัง



C มีช่องสำหรับร้อยสายเคเบิลจากด้านบน

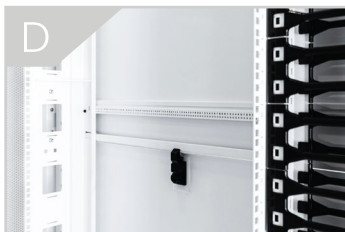

D เสา U (เสาแนวตั้ง) สามารถปรับตำแหน่งได้ และมีหมายเลขระบุแต่ละ Unit เพื่ออำนวยความสะดวกในการติดตั้งอุปกรณ์



E มาตรฐานติดตั้งและล็อกที่แข็งแรง สามารถปรับเปลี่ยนได้ตามการใช้งาน รองรับน้ำหนักสูงสุด 1,500 กิโลกรัม ช่วยให้การวางแผนติดตั้ง และการเคลื่อนย้ายไปยังตำแหน่งติดตั้งสุดท้ายเป็นไปได้อย่างสะดวก



F ฝาตู้ด้านข้างถูกออกแบบให้แบ่งเป็น 2 ส่วน สามารถปลดล็อกเพื่อเปิดเฉพาะส่วนได้ ช่วยให้การจัดการง่ายขึ้นและเพิ่มความสะดวกในการจัดการอุปกรณ์

## Ordering Number : LC Pure White Series

Part Number	Description	Capacity (U)	Dimension W x D x H (mm.)	Price
LMZ-LCWH60637-WD	LIMAZ Cabinet LC Series 37U, 600x600 mm., white	37	600 x 600 x 1770	<b>Call</b>
LMZ-LCWH60837-WD	LIMAZ Cabinet LC Series 37U, 600x800 mm., white	37	600 x 800 x 1770	<b>Call</b>
LMZ-LCWH60642-WD	LIMAZ Cabinet LC Series 42U, 600x600 mm., white	42	600 x 600 x 1992	<b>51,500.-</b>
LMZ-LCWH60842-WD	LIMAZ Cabinet LC Series 42U, 600x800 mm., white	42	600 x 800 x 1992	<b>52,500.-</b>
LMZ-LCWH61042-WD	LIMAZ Cabinet LC Series 42U, 600x1000 mm., white	42	600 x 1000 x 1992	<b>54,500.-</b>
LMZ-LCWH61142-WD	LIMAZ Cabinet LC Series 42U, 600x1100 mm., white	42	600 x 1100 x 1992	<b>55,300.-</b>
LMZ-LCWH61242-WD	LIMAZ Cabinet LC Series 42U, 600x1200 mm., white	42	600 x 1200 x 1992	<b>59,100.-</b>
LMZ-LCWH80842-WD	LIMAZ Cabinet LC Series 42U, 800x800 mm., white	42	800 x 800 x 1992	<b>52,500.-</b>
LMZ-LCWH81042-WD	LIMAZ Cabinet LC Series 42U, 800x1000 mm., white	42	800 x 1000 x 1992	<b>72,900.-</b>
LMZ-LCWH81142-WD	LIMAZ Cabinet LC Series 42U, 800x1100 mm., white	42	800 x 1100 x 1992	<b>74,300.-</b>
LMZ-LCWH81242-WD	LIMAZ Cabinet LC Series 42U, 800x1200 mm., white	42	800 x 1200 x 1992	<b>76,700.-</b>
LMZ-LCWH61245-WD	LIMAZ Cabinet LC Series 45U, 600x1200 mm., white	45	600 x 1200 x 2125	<b>Call</b>
LMZ-LCWH61248-WD	LIMAZ Cabinet LC Series 48U, 600x1200 mm., white	48	600 x 1200 x 2260	<b>Call</b>

### Door Type

**WD**= Perforate & Double Door, **DD** = Double Door & Double Door

\*Height when removing casters If adding casters, the height will increase by another 50 mm.

Can adjust additional height.

## Ordering Number : LCB Pure White Series

Part Number	Description	Capacity (U)	Dimension W x D x H (mm.)	Price
LMZ-LCBWH60642-PD	LIMAZ LCB Cabinet [Curved-Double Perforated Door], 600x600 mm., 42U, white	42	600 x 600 x 2055	<b>19,300.-</b>
LMZ-LCBWH60842-PD	LIMAZ LCB Cabinet [Curved-Double Perforated Door], 600x800 mm., 42U, white	42	600 x 800 x 2055	<b>22,600.-</b>
LMZ-LCBWH61042-PD	LIMAZ LCB Cabinet [Curved-Double Perforated Door], 600x1000 mm., 42U, white	42	600 x 1000 x 2055	<b>26,200.-</b>
LMZ-LCBWH61142-PD	LIMAZ LCB Cabinet [Curved-Double Perforated Door], 600x1100 mm., 42U, white	42	600 x 1100 x 2055	<b>30,500.-</b>
LMZ-LCBWH61242-PD	LIMAZ LCB Cabinet [Curved-Double Perforated Door], 600x1200 mm., 42U, white	42	600 x 1200 x 2055	<b>31,100.-</b>
LMZ-LCBWH80842-PD	LIMAZ LCB Cabinet [Curved-Double Perforated Door], 800x800 mm., 42U, white	42	800 x 800 x 2055	<b>30,400.-</b>
LMZ-LCBWH81042-PD	LIMAZ LCB Cabinet [Curved-Double Perforated Door], 800x1000 mm., 42U, white	42	800 x 1000 x 2055	<b>30,300.-</b>
LMZ-LCBWH81142-PD	LIMAZ LCB Cabinet [Curved-Double Perforated Door], 800x1100 mm., 42U, white	42	800 x 1100 x 2055	<b>34,300.-</b>
LMZ-LCBWH81242-PD	LIMAZ LCB Cabinet [Curved-Double Perforated Door], 800x1200 mm., 42U, white	42	800 x 1200 x 2055	<b>36,600.-</b>
LMZ-LCBWH61245-PD	LIMAZ LCB Cabinet [Curved -Double Perforated Door], 600x1200 mm., 45U, white	45	600 x 1200 x 2190	<b>Call</b>
LMZ-LCBWH81245-PD	LIMAZ LCB Cabinet [Curved-Double Perforated Door], 800x1200 mm., 45U, white	45	800 x 1200 x 2190	<b>Call</b>

### OPTIONAL DOORS

**PD** = Front Curved Perforated - Rear Double Perforated Door

**DD** = Front Double Perforated - Rear Double Perforated Door

# Pure White Series

## LCB | LIMAZ Cabinet Business



### General Specification

- Cabinet solution adaptable to server, network, data center or mixed-use application
- Various doors optional: glass, acrylic, vented or solid doors
- Static loading capacity up to 1,000 kg.
- Modular knock down can be shipped in build-up or flat-packed (saving 60% space)
- Four mounting ears depth adjustable fixed shelf
- Fan tray with 2 or more, with metal cover



### Details



A ประตูหน้าบานเดี่ยวทรงโค้งแบบรูปพวง  
มีความสามารถในการระบายอากาศ  
ได้สูงถึง 80%



B ประตูด้านหลังเป็นแบบบานคู่ เพื่อลดพื้นที่  
ในการเข้าจัดการอุปกรณ์จากทางด้านหลัง



C แคมกาดพัดลม มี 2 ขนาดให้เลือกตามความลึก  
(พัดลม 2 ตัวสำหรับชั้นวางลึก 600 มม. และ  
พัดลม 4 ตัวสำหรับชั้นวางลึก 800 มม. หรือ  
1,000 มม.-1,200 มม.) ช่วยให้เพิ่ม Airflow  
ภายในตู้



D สามารถเลื่อนตำแหน่งเสาได้ตามความลึก  
ที่ต้องการ และยึดให้แน่นอีกครั้ง



E มาพร้อมขาตั้งและล้อที่แข็งแรง สามารถปรับ  
เปลี่ยนได้ตามการใช้งาน รองรับน้ำหนักสูงสุด  
1,000 กิโลกรัม ช่วยให้การวางแบบติดตั้ง และ  
การเคลื่อนย้ายไปยังตำแหน่งติดตั้งสุดท้าย  
เป็นไปได้อย่างสะดวก

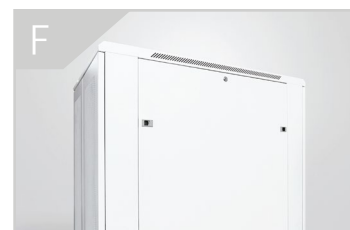

F ฝาด้านข้างสามารถล็อกด้วยกุญแจ และถอด  
ออกได้

# Pure White Series

## LWC | LIMAZ Wall Cabinet



### General Specification

- Double Section Structure Swing frame allows the cabinet to swing away from the wall for easy access to equipments and cabling
- Sturdy Welded Construction Fully welded and assembled
- Loading Capacity The loading capacity is up to 65 kg.
- Optional doors Toughened glass or vented door is optional, which is at your choice
- Big door-opening angle Turning angle of front door is over 180 degrees; rear door is over 90 degrees



### Details



A โครงสร้างแข็งแรง ประกอบและติดตั้งง่าย

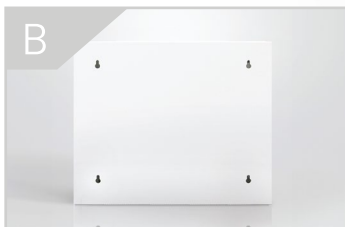

B ช่องด้านหลังช่วยให้ติดตั้งบนผนังได้สะดวกและรวดเร็ว



C พัดลมขนาด 120 มม.\*120 มม. สามารถติดตั้งมาพร้อมกับตู้บนฝาครอบด้านบน ไม่กินพื้นที่ภายในตู้



D โครงแบบ 4 เสา และประตูหลังเป็นแบบสวิง ช่วยเพื่อเข้าถึงอุปกรณ์และจัดการด้านหลังได้ง่ายขึ้น



E ฝาด้านข้างแบบถอดออกได้ช่วยให้คุณติดตั้งอุปกรณ์เสริมและจัดการอุปกรณ์ได้ง่ายยิ่งขึ้น



F ประตูกระจกนิรภัยมาพร้อม กับ สปริงรูปตัวแอล ช่วยให้คุณติดตั้งประตูหน้าเข้ากับกรอบประตูได้อย่างรวดเร็ว และเปลี่ยนทิศทางการเปิดประตูได้อย่างง่ายดาย

**Ordering Number : LWC Pure White Series**

Part Number	Description	Capacity (U)	Dimension W x D x H (mm.)	Price
LMZ-LWCWH60406	LIMAZ LWC Cabinet, 6U	6	600 x 400 x 370	<b>7,400.-</b>
LMZ-LWCWH60506	LIMAZ LWC Cabinet, 6U	6	600 x 550 x 370	<b>7,800.-</b>
LMZ-LWCWH60606	LIMAZ LWC Cabinet, 6U	6	600 x 600 x 370	<b>8,150.-</b>
LMZ-LWCWH60409	LIMAZ LWC Cabinet, 9U	9	600 x 400 x 500	<b>8,450.-</b>
LMZ-LWCWH60509	LIMAZ LWC Cabinet, 9U	9	600 x 550 x 500	<b>8,850.-</b>
LMZ-LWCWH60609	LIMAZ LWC Cabinet, 9U	9	600 x 600 x 500	<b>9,150.-</b>
LMZ-LWCWH60412	LIMAZ LWC Cabinet, 12U	12	600 x 400 x 635	<b>9,000.-</b>
LMZ-LWCWH60512	LIMAZ LWC Cabinet, 12U	12	600 x 550 x 635	<b>9,750.-</b>
LMZ-LWCWH60612	LIMAZ LWC Cabinet, 12U	12	600 x 600 x 635	<b>10,600.-</b>

# Black Series

## LC | LIMAZ Cabinet



### General Specification

- Cabinet solution adaptable to server, network, data center or mixed-use application.
- Perforated doors for massive front-to-rear airflow up to 80%.
- Static loading capacity up to 1,500 kg. (without levelling feet and castors).
- Universal, 19" W, vertical hole spacing complies with EIA-310E (3 holes)
- Solutions are available for traditional hot aisle/cold aisle environments and containment.
- Modular knock down can be shipped in build-up or flat-packed (saving 60% space).
- Swing handle latch with 3 digits keyed lock.



A ประตูบานเดี่ยวแบบรูพรุนที่สามารถระบายอากาศได้มากถึง 80%



B ประตูด้านหลังเป็นแบบบานคู่ เพื่อลดพื้นที่ในการเข้าถึงและจัดการ



C มีช่องสำหรับร้อยสายเคเบิลจากด้านบน



D เสา U (เสาแนวตั้ง) สามารถปรับตำแหน่งได้ และมีหมายเลขระบุแต่ละ Unit เพื่ออำนวยความสะดวกในการติดตั้งอุปกรณ์

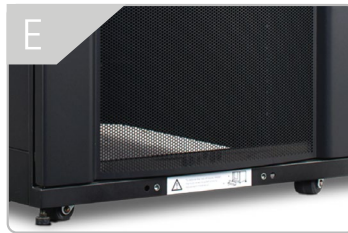

E มาพร้อมขาตั้งและล้อที่แข็งแรง สามารถปรับเปลี่ยนได้ตามการใช้งาน รองรับน้ำหนักสูงสุด 1,500 กิโลกรัม ช่วยให้การวางแผนติดตั้ง และการเคลื่อนย้ายไปยังตำแหน่งติดตั้งสุดท้ายเป็นไปได้อย่างสะดวก



F ฝาตู้ด้านข้างถูกออกแบบให้แบ่งเป็น 2 ส่วน สามารถปลดล็อกเพื่อเปิดเฉพาะส่วนได้ ช่วยให้การจัดการง่ายขึ้นและเพิ่มความสะดวกในการเข้าถึงอุปกรณ์

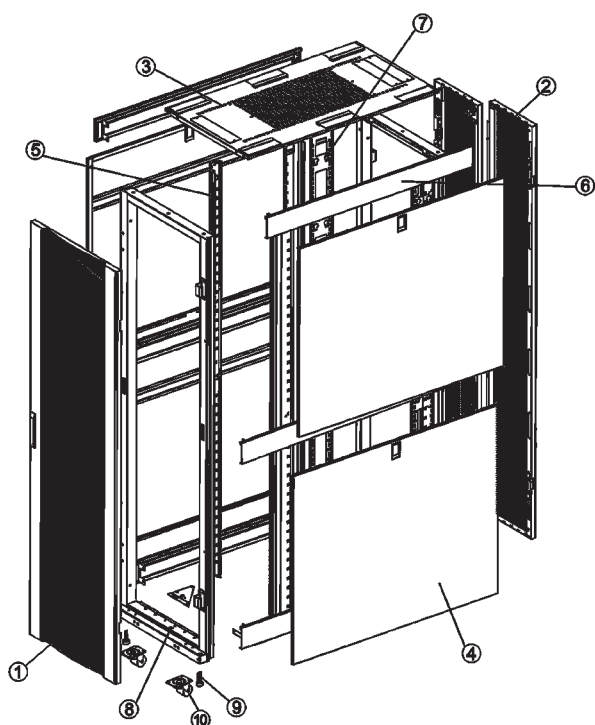

LC Series Assembly			
NO.	Description	Quantity (24U)	Quantity (42/48U)
1	Front vented door	1	1
2	Rear door	2	2
3	Top cover	1	1
4	Side panel	2	4
5	Vertical rail	4	4
6	Horizontal beam	4	6
7	Cable management rail	2	2
8	Door frame	2	2
9	Levelling feet	4	4
10	2" heavy duty castor	4	4

### Ordering Number

Part Number	Description	Capacity (U)	Dimension W x D x H (mm.)	Price
LMZ-LC60642-XX	LIMAZ Cabinet LC Series 42U, 600x600 mm.	42	600 x 600 x 1992	<b>51,500.-</b>
LMZ-LC60842-XX	LIMAZ Cabinet LC Series 42U, 600x800 mm.	42	600 x 800 x 1992	<b>52,500.-</b>
LMZ-LC61042-XX	LIMAZ Cabinet LC Series 42U, 600x1,000 mm.	42	600 x 1000 x 1992	<b>54,500.-</b>
LMZ-LC61142-XX	LIMAZ Cabinet LC Series 42U, 600x1,100 mm.	42	600 x 1100 x 1992	<b>55,300.-</b>
LMZ-LC61242-XX	LIMAZ Cabinet LC Series 42U, 600x1,200 mm.	42	600 x 1200 x 1992	<b>59,100.-</b>
LMZ-LC80842-XX	LIMAZ Cabinet LC Series 42U, 800x800 mm.	42	800 x 800 x 1992	<b>52,500.-</b>
LMZ-LC81042-XX	LIMAZ Cabinet LC Series 42U, 800x1,000 mm.	42	800 x 1000 x 1992	<b>72,900.-</b>
LMZ-LC81142-XX	LIMAZ Cabinet LC Series 42U, 800x1,100 mm.	42	800 x 1100 x 1992	<b>74,300.-</b>
LMZ-LC81242-XX	LIMAZ Cabinet LC Series 42U, 800x1,200 mm.	42	800 x 1200 x 1992	<b>76,700.-</b>

Door Type : PD = Perforate & Double Door | DD = Double Door & Double Door



# Black Series

## LCK | LIMAZ Cabinet Komplete



### General Specification

#### KEY FEATURES

- Cabinet solution adaptable to server, network, datacenter or mixed mixed-use application, close rack.
- Perforated doors for massive front-to-rear airflow up to 80%.
- Easy installation of front and rear door
- Side panel are removable and lockable, improving ease of installation and service
- Static loading capacity up to 1200 kg
- Universal, 19" W, vertical hole spacing complies with EIA-310E
- Solutions are available for traditional hot aisle/cold aisle environments and containment.
- Modular knock down can be shipped in build-up or flat-packed (saving 60% space).



A ประตูบานเดี่ยวแบบรูพรุนที่สามารถระบายอากาศได้มากถึง 80%

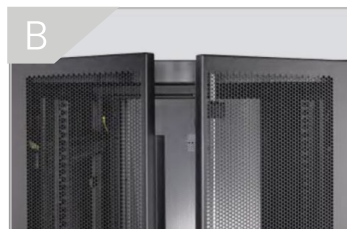

B ประตูด้านหลังเป็นแบบบานคู่ เพื่อลดพื้นที่ในการเข้าถึงและจัดการ



C แผงด้านบนแบบทึบพร้อมรูเคเบิลขนาดใหญ่บนหลังคา เพื่อให้ร้อยสายเคเบิลเหนือศีรษะได้ ช่องเข้าถึงสายเคเบิลปิดด้วยแผง Brush



D ฝาด้านข้างสามารถล็อกด้วยกุญแจ และถอดออกได้



E แถบแผ่นปิดช่องร้อยสาย (ตัวเลือกเสริมแผง Brush)



F กราวด์/การต่อสายดิน : แผ่นด้านล่างและประตูได้รับการต่อสายดินด้วยไฟฟ้า

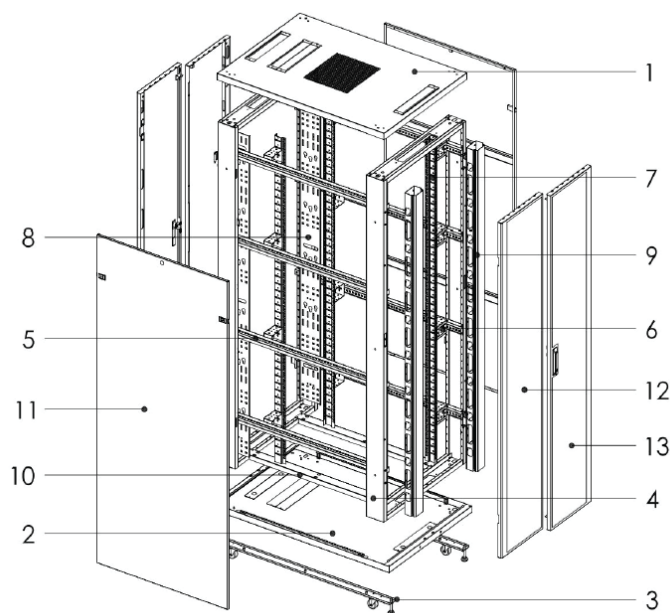

### LCK Series Assembly

NO.	Description	Quantity (600mm. width)	Quantity (800mm. width)
1	Top cover	1	1
2	Bottom plate	1	1
3	Castor component	2	2
4	Door frame	2	2
5	Horizontal beam	8	8
6	Connecting box	/	16
7	Vertical rail	4	4
8	Cable rail	2	2
9	Cable management rail	/	2
10	Bottom fixed plate	2	2
11	Side panel	2	2
12	Split vented door-L	1	1
13	Split vented door-R	1	1

### Ordering Number

Part Number	Description	Capacity (U)	Dimension W x D x H (mm.)	Price
LMZ-LCK60637-XX	LIMAZ Cabinet LCK Series 37U, 600x600 mm.	37	600 x 600 x 1850	<b>Call</b>
LMZ-LCK60837-XX	LIMAZ Cabinet LCK Series 37U, 600x800 mm.	37	600 x 800 x 1850	<b>Call</b>
LMZ-LCK60642-XX	LIMAZ Cabinet LCK Series 42U, 600x600 mm.	42	600 x 600 x 2055	<b>43,500.-</b>
LMZ-LCK60842-XX	LIMAZ Cabinet LCK Series 42U, 600x800 mm.	42	600 x 800 x 2055	<b>45,300.-</b>
LMZ-LCK61142-XX	LIMAZ Cabinet LCK Series 42U, 600x1,100 mm.	42	600 x 1100 x 2055	<b>51,500.-</b>
LMZ-LCK61242-XX	LIMAZ Cabinet LCK Series 42U, 600x1,200 mm.	42	600 x 1200 x 2055	<b>52,500.-</b>
LMZ-LCK80842-XX	LIMAZ Cabinet LCK Series 42U, 800x800 mm.	42	800 x 800 x 2055	<b>56,100.-</b>
LMZ-LCK81142-XX	LIMAZ Cabinet LCK Series 42U, 800x1,100 mm.	42	800 x 1100 x 2055	<b>62,800.-</b>
LMZ-LCK81242-XX	LIMAZ Cabinet LCK Series 42U, 800x1,200 mm.	42	800 x 1200 x 2055	<b>64,300.-</b>
LMZ-LCK61245-XX	LIMAZ Cabinet LCK Series 45U, 600x1,200 mm.	45	600 x 1200 x 2133.5	<b>60,700.-</b>
LMZ-LCK81245-XX	LIMAZ Cabinet LCK Series 45U, 800x1,200 mm.	45	800 x 1200 x 2133.5	<b>72,400.-</b>

Door Type : PD = Perforate & Double Door | DD = Double Door & Double Door

# Black Series

## LCB | LIMAZ Cabinet Business



A ประตูหน้าแบบกระจกนิรภัยพร้อมล็อกกุญแจ



B ประตูหลังเหล็กทึบพร้อมกุญแจ และมีประตูแบบอื่นๆให้เลือกอีกด้วย



C แคมกาดพัดลม มี 2 ขนาดให้เลือกตามความลึก (พัดลม 2 ตัวสำหรับชั้นวางลึก 600 มม. และพัดลม 4 ตัวสำหรับชั้นวางลึก 800 มม. หรือ 1,000 มม.) ช่วยให้เพิ่ม Airflow ภายในตู้



D แผงด้านข้างสามารถล็อก และถอดออกได้



E โครงสร้างประกอบง่ายช่วยลดระยะเวลาการติดตั้ง



F สามารถเลื่อนตำแหน่งเสาได้ตามความลึกที่ต้องการ และยึดให้แน่นอีกครั้ง



### General Specification

- Cabinet solution adaptable to server, network, data center or mixed-use application
- Various doors optional: glass, acrylic, vented or solid doors
- Static loading capacity up to 1,000 kg.
- Modular knock down can be shipped in build-up or flat-packed (saving 60% space)
- Four mounting ears depth adjustable fixed shelf
- Fan tray with 2 or more, with metal cover



Tempered glass door  
Lock : 3 Digits Keyed Lock



Solid iron door  
Lock : Small Round Lock



Arc & curved door  
Lock : Spring Lock



Split vented door  
Lock : Moon Light Lock

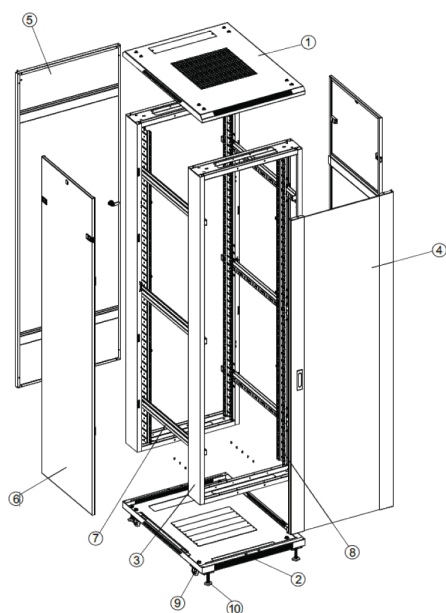

### LCB Series Assembly

NO.	Description	Quantity (≤32U)	Quantity (>32U)
1	Top cover	1	1
2	Bottom panel	1	1
3	Door frame	2	2
4	Front door	1	1
5	Rear door	1	1
6	Side panel	2	2
7	Horizontal beam	4	6
8	Vertical rail	4	4
9	Castor	4	4
10	Levelling feet	4	4

### Ordering Number

Part Number	Description	Price
LMZ-LCB60615-TS	LIMAZ Cabinet LCB Series 15U 600x600mm	<b>14,800</b>
LMZ-LCB60815-TS	LIMAZ Cabinet LCB Series 15U 600x800mm	<b>18,500</b>
LMZ-LCB60627-TS	LIMAZ Cabinet LCB Series 27U 600x600mm	<b>18,300</b>
LMZ-LCB60827-TS	LIMAZ Cabinet LCB Series 27U 600x800mm	<b>23,400</b>
LMZ-LCB60637-TS	LIMAZ Cabinet LCB Series 37U 600x600mm	<b>26,550</b>
LMZ-LCB60837-TS	LIMAZ Cabinet LCB Series 37U 600x800mm	<b>30,550</b>
LMZ-LCB606-42	LIMAZ Cabinet LCB Series 42U 600x600mm without door	<b>19,300</b>
LMZ-LCB608-42	LIMAZ Cabinet LCB Series 42U 600x800mm without door	<b>22,600</b>
LMZ-LCB610-42	LIMAZ Cabinet LCB Series 42U 600x1000mm without door	<b>26,200</b>
LMZ-LCB611-42	LIMAZ Cabinet LCB Series 42U 600x1100mm without door	<b>30,500</b>
LMZ-LCB612-42	LIMAZ Cabinet LCB Series 42U 600x1200mm without door	<b>31,100</b>
LMZ-LCB808-42	LIMAZ Cabinet LCB Series 42U 800x800mm without door	<b>30,400</b>
LMZ-LCB810-42	LIMAZ Cabinet LCB Series 42U 800x1000mm without door	<b>33,300</b>
LMZ-LCB811-42	LIMAZ Cabinet LCB Series 42U 800x1100mm without door	<b>34,300</b>
LMZ-LCB812-42	LIMAZ Cabinet LCB Series 42U 800x1200mm without door	<b>36,600</b>
LMZ-DB60042-P	LIMAZ Perforated Door 42U 600mm for LCB Series	<b>4,480</b>
LMZ-DB80042-P	LIMAZ Perforated Door 42U 800mm for LCB Series	<b>5,550</b>
LMZ-DB60042-D	LIMAZ Double Perforated Door 42U 600mm for LCB Series	<b>4,480</b>
LMZ-DB80042-D	LIMAZ Double Perforated Door 42U 800mm for LCB Series	<b>5,550</b>
LMZ-DB60042-T	LIMAZ Tempered Glass Door 42U 600mm for LCB Series	<b>2,630</b>
LMZ-DB80042-T	LIMAZ Tempered Glass Door 42U 800mm for LCB Series	<b>3,080</b>
LMZ-DB60042-S	LIMAZ Solid Door 42U 600mm for LCB Series	<b>2,300</b>
LMZ-DB80042-S	LIMAZ Solid Door 42U 800mm for LCB Series	<b>2,900</b>

# Black Series

## LWC | LIMAZ Wall Cabinet



โครงสร้างแข็งแรง ประกอบและติดตั้งง่าย



ช่องด้านหลังช่วยให้ติดตั้งบนผนังได้สะดวกและรวดเร็ว



พัดลมขนาด 120 มม.\*120 มม. สามารถติดตั้งมาพร้อมกับตู้บนฝาครอบด้านบนไม่กินพื้นที่ภายในตู้



โครงแบบ 4 เสา และประตูหลังเป็นแบบสวิง ช่วยเข้าถึงอุปกรณ์และจัดการด้านหลังได้ง่ายขึ้น



ฝาด้านข้างแบบถอดออกได้ช่วยให้คุณติดตั้งอุปกรณ์เสริมและจัดการอุปกรณ์ได้ง่ายยิ่งขึ้น



ประตูกระจกนิรภัยมาพร้อมกับ สปริงรูปตัวแอล ช่วยให้ติดตั้งประตูหน้าเข้ากับกรอบประตูได้อย่างรวดเร็ว และเปลี่ยนทิศทางการเปิดประตูได้อย่างง่ายดาย



### General Specification

- Double Section Structure
- Sturdy Welded Construction
- Loading Capacity
- Optional doors
- Big door-opening angle

Swing frame allows the cabinet to swing away from the wall for easy access to equipments and cabling

Fully welded and assembled

The loading capacity is up to 65 kg.

Toughened glass or vented door is optional, which is at your choice

Turning angle of front door is over 180 degrees;

rear door is over 90 degrees

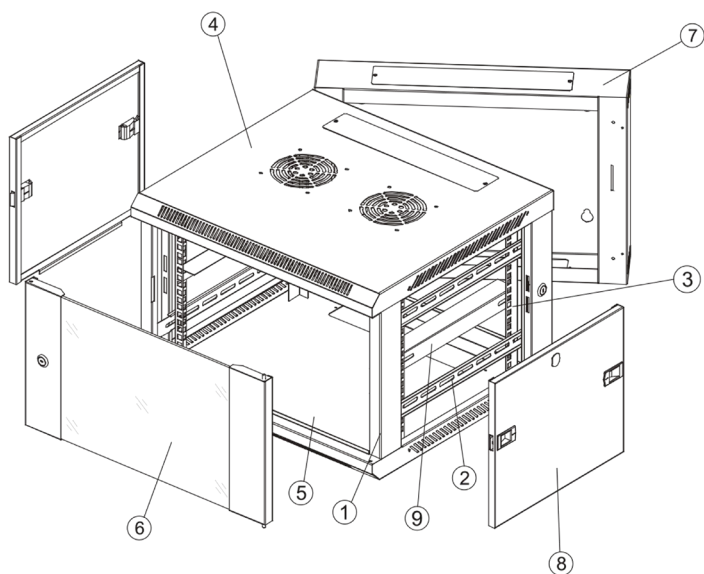

### LCW Series Assembly

NO.	Description	Quantity
1	Frame	1
2	Horizontal bracket	4
3	Vertical rail	4
4	Top cover	1
5	Bottom panel	1
6	Front door	1
7	Rear swing frame	1
8	Side panel	2
9	L-shaped bracket	2

### Ordering Number

Part Number	Description	Capacity (U)	Dimension W x D x H (mm.)	Price
LMZ-LWC60406	LIMAZ LWC Cabinet, 6U	6	600 x 400 x 370	<b>7,400.-</b>
LMZ-LWC60506	LIMAZ LWC Cabinet, 6U	6	600 x 500 x 370	<b>7,800.-</b>
LMZ-LWC60606	LIMAZ LWC Cabinet, 6U	6	600 x 600 x 370	<b>8,150.-</b>
LMZ-LWC60409	LIMAZ LWC Cabinet, 9U	9	600 x 400 x 500	<b>8,450.-</b>
LMZ-LWC60509	LIMAZ LWC Cabinet, 9U	9	600 x 550 x 500	<b>8,850.-</b>
LMZ-LWC60609	LIMAZ LWC Cabinet, 9U	9	600 x 600 x 500	<b>9,150.-</b>
LMZ-LWC60412	LIMAZ LWC Cabinet, 12U	12	600 x 400 x 635	<b>9,000.-</b>
LMZ-LWC60512	LIMAZ LWC Cabinet, 12U	12	600 x 550 x 635	<b>9,750.-</b>
LMZ-LWC60612	LIMAZ LWC Cabinet, 12U	12	600 x 600 x 635	<b>10,600.-</b>

# Cold Containment

## Aisle Containment

ระบบกักลมเย็นและลมร้อน ที่ใช้เพื่อควบคุมการไหลของอากาศภายในห้องดาต้าเซ็นเตอร์ โดยการแบ่งพื้นที่ภายในแนวทางเดิน (Aisle) เป็นส่วนๆ ซึ่งแยกอากาศเย็นและร้อนจากอุปกรณ์ โดยมีวัตถุประสงค์เพื่อเพิ่มประสิทธิภาพในการทำความเย็นของอุปกรณ์ไอที และลดการใช้พลังงานในการควบคุมสภาพแวดล้อมของห้องดาต้าเซ็นเตอร์



### General Specification

- Modular design : Most parts of the aisle containment components are designed by modular, which allows quick deployment on site and address changing needs or future expansion with pay-as-you grow architecture.
- Customized design : According to different requirements of customers, different modular design is made to adapt to cold aisle containment, single or dual unit, even in building pillars solution.
- Humanized design :
  - Separate controlled switch device at the roof ceiling, which can make test by each row-based modular as unit.
  - Optional lighting system.
  - Semi-automatic or full-automatic sliding doors are easy for using.
  - Sensor or access control locking system can easily be used to open and close the door.
- High intelligent degree : Flip design on roof ceiling, to be connected with fire protection through intelligent control box. The roof ceiling will automatically open, when fire signal received. And fire-extinguishing gas will come into aisle, without conflict to the existing fire protection system.

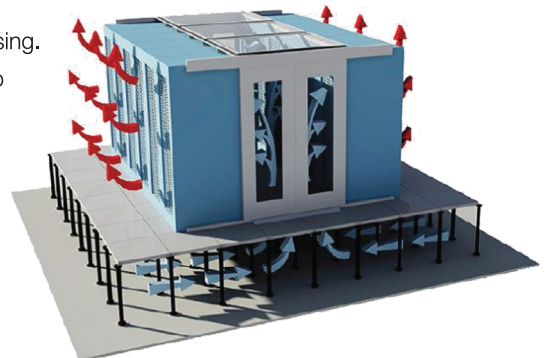

Effective airflow management

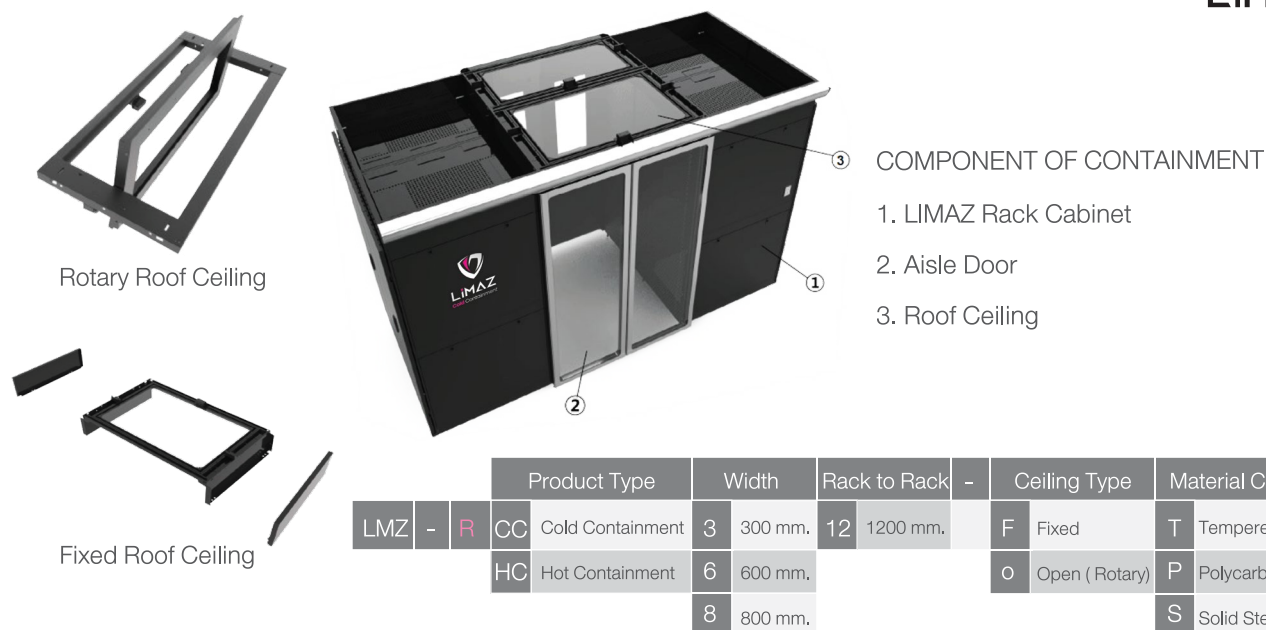

## Ordering Number

Part Number	Description	Price
LMZ-RCC612-FT	Cold Containment Fixed Roof Ceiling, Tempered Glass, 600 x 1,200 mm.	<b>Call</b>
LMZ-RCC812-FT	Cold Containment Fixed Roof Ceiling, Tempered Glass, 800 x 1,200 mm.	<b>Call</b>
LMZ-RCC612-FP	Cold Containment Fixed Roof Ceiling, Polycarbonate, 600 x 1,200 mm.	<b>Call</b>
LMZ-RCC812-FP	Cold Containment Fixed Roof Ceiling, Polycarbonate, 800 x 1,200 mm.	<b>Call</b>
LMZ-RCC612-OT	Cold Containment Rotary Roof Ceiling, Tempered Glass, 600 x 1,200 mm.	<b>Call</b>
LMZ-RCC812-OT	Cold Containment Rotary Roof Ceiling, Tempered Glass, 800 x 1,200 mm.	<b>Call</b>
LMZ-RCCA01	Control Box&Power Supply	<b>Call</b>

**Note :** Height of decoration panel and fixed plate only have 300 mm.

		Product Type	Width	Hight ( RU )	-	Door Type	Door Mode
LMZ	- R DC	Door Containment	12 1200 mm.	42 42U		M Mechanical Door	A Manual
				45 45U		S Sliding Door	B Semi-Auto
							C Full Auto



Dual Mechanical doors with key

## Ordering Number

Part Number	Description	Price
LMZ-RDC1242-MB	Aisle Mechanical Door 42U, toughened glass, Semi-automatic mode	<b>Call</b>
LMZ-RDC1242-SA	Aisle Sliding Door 42U, toughened glass, Manual mode	<b>Call</b>
LMZ-RDC1242-SB	Aisle Sliding Door 42U, toughened glass, Semi-automatic mode	<b>Call</b>
LMZ-RDC1242-SC	Aisle Sliding Door 42U, toughened glass, Full-automatic mode	<b>Call</b>
LMZ-RDC1245-SC	Aisle Sliding Door 45U, toughened glass, Full-automatic mode	<b>Call</b>



Sliding doors with key



## Fingerprint Access Control



### Advantage

- Shockproof / Pickproof / Waterproof
- All metal integration material (Zinc alloy)
- European standard lock cylinder
- Lock key function

## Access Control



### Advantage

- Shockproof / Pickproof / Waterproof
- All metal integration material (Zinc alloy)
- European standard lock cylinder
- Lock key function
- IP65 / waterproof

## Access Control Cabinet Lock



### Advantage

- Cut size can be customized
- European standard cylinder
- IP65 / waterproof
- Support RS485 communication

## Other Related Products



### Desktop Card Issuer

**Working frequency :** 3.56MHz (Support Mifare Card)

**Power supply :** get power from USB port direct

**Communication interface :** Standard USB interface

## Ordering Number

Part Number	Description	Price
LMZ-ELEK15	LIMAZ Electronic Lock two authentication Proximity Card and Keypad Cut size (150 x 25mm.)	Call
LMZ-ELEK16	LIMAZ Electronic Lock two authentication Proximity Card and Keypad Cut size (160 x 32mm.)	Call
LMZ-ELF15	LIMAZ Electronic Lock Fingerprint Access Control lock (150 x 25mm.)	Call
LMZ-ELF16	LIMAZ Electronic Lock Fingerprint Access Control lock (160 x 32mm.)	Call
LMZ-ELK15	LIMAZ Electronic Lock Keypad Access Control lock (150 x 25mm.)	Call
LMZ-ELK16	LIMAZ Electronic Lock Keypad Access Control lock (160 x 32mm.)	Call
LMZ-ELC15	LIMAZ Electronic Lock Card Access Control lock (150 x 25mm.)	Call
LMZ-ELC16	LIMAZ Electronic Lock Card Access Control lock (160 x 32mm.)	Call
LMZ-ELCONBOX	Electronics lock smart controller box	Call
LMZ-ELA09	Software Unlimited License	Call

# Power Distribution Unit

## Basic PDU



### General Specification

Power input method	16A NEMA5-15P; 3 x 16 AWG, 3 m., 32A industrial plug (IEC 60309); 3 x 6.0 Sqmm. , 3 m.
Power Control	1 or 2 Pole Circuit Breaker with cover protection
Protective Function	Single power indicator, Surge protective
Output unit	Universal, 10A 250VAC, IEC 60320C13 [C13] 10A 250VAC, IEC 60320C19 [C19] 16A 250VAC [Lockable port for option]
Rated voltage	220—250V, 50-60 Hz
Rated current	16A, 32A
Material	Aluminum alloy
Color	Black (RAL9005), Blue, Red
Operating Temp.	0°C to 55°C
Storage Temp.	25°C to 85°C
Safety certification	CE, RoHS, UL94V-0



### General Specification

- Horizontal 19" rack mountable, Vertical suitable for rack mounting.
- Different kinds power input
- Various international plug/socket types available
- Diverse design on fixed components to meet 360° all-round assembly requirement
- Master on/off switch ; 1 Pole or 2 Pole Circuit Breaker
- Single power indicator and Surge protective

### Ordering Number

Part Number	Description	Price
LMZ-PBNMU06	LIMAZ Basic PDU 6 Universal Outlet, 1P Circuit Breaker, NEMA5-15P, 16A	<b>1,450.-</b>
LMZ-PBNMU12	LIMAZ Basic PDU 12 Universal Outlet, 1P Circuit Breaker, NEMA5-15P, 16A	<b>2,250.-</b>
LMZ-PBP2U12	LIMAZ Basic PDU 12 Universal Outlet, 2P Circuit Breaker with Surge, Power Plug 32A	<b>5,600.-</b>
LMZ-PBP2U24	LIMAZ Basic PDU 24 Universal Outlet, 2P Circuit Breaker with Surge, Power Plug 32A	<b>7,350.-</b>
LMZ-PBP2T20N04	LIMAZ Basic PDU 20 C13, 4 C19 Outlet, 2P Circuit Breaker with Surge, Power Plug 32A	<b>6,300.-</b>
LMZ-PBP2UXXYYNZZ	LIMAZ Basic PDU XX Universal Outlet, YY C13 Outlet, ZZ C19 Outlet	<b>Call</b>

**UXX** = Q'ty Receptacle Universal Outlets ; 04, 06, 12, 16, 20, 36 Universal Outlet

**YYY** = Q'ty Receptacle C13 Outlets ; 04, 06, 12, 16, 20, 36 C13 Outlet

**NZZ** = Q'ty Receptacle C19 Outlets ; 04, 06, 12, 16, 20, 36 C19 Outlet

# Power Distribution Unit

## Local Metered PDU



### General Specification

- Horizontal 19" rack mountable, Vertical suitable for rack mounting.
- Various countries plug/socket types available, including: Britain, American, Germany, IEC, etc.
- Master on/off switch with protection.
- Black plastic and Sheet Metal body.
- Show Voltage and Current
- Lockable port for option

### Ordering Number

Part Number	Description	Price
LMZ-PLP2U12	LIMAZ Local Metered PDU 12 Universal Outlet, 32A	Call
LMZ-PLP2U20	LIMAZ Local Metered PDU 20 Universal Outlet, 32A	Call
LMZ-PLP2U24	LIMAZ Local Metered PDU 24 Universal Outlet, 32A	Call
LMZ-PLP2UXXTYYNZZ	LIMAZ Local Metered PDU XX Universal Outlet, YY C13 Outlet, ZZ C19 Outlet	Call

UXX = Q'ty Receptacle Universal Outlets ; 04, 06, 12, 16, 20, 36 Universal Outlet

TY Y = Q'ty Receptacle C13 Outlets ; 04, 06, 12, 16, 20, 36 C13 Outlet

NZZ = Q'ty Receptacle C19 Outlets ; 04, 06, 12, 16, 20, 36 C19 Outlet

# Power Distribution Unit

## Monitored PDU

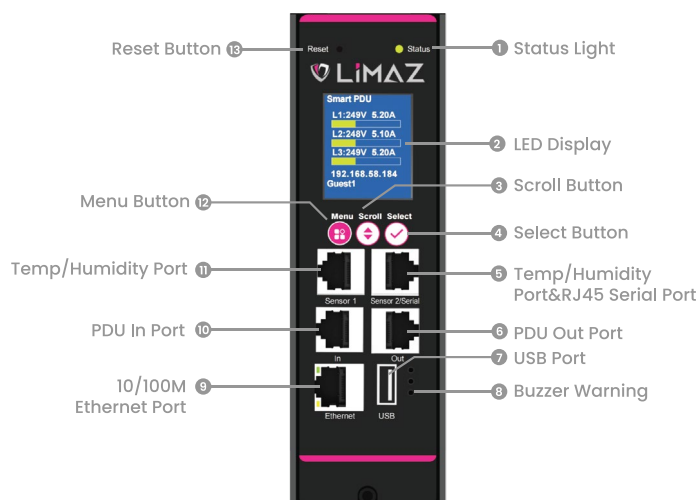

### General Specification

- LCD view the total Voltage, total Power, total Electrical Energy, Power Factor, Load Current of each output unit
- Optimizes power usage in high-density applications with continuous power monitoring at each PDU
- Delivers proactive environmental warnings and threshold alarms with integrated temperature and humidity monitoring
- Allows the use of a single IP address for connected other PDU
- Sensors : Temperature/Humidity state
- Multiple Alarms Method : Buzzer beep, Font color to red when view work state, E-mail is automatically sent to the system administrator, SNMP sent Trap alarm information.

### Ordering Number

Part Number	Description	Price
LMZ-PMP2U12	LIMAZ Monitored PDU 12 Universal Outlet, 32A	Call
LMZ-PMP2U20	LIMAZ Monitored PDU 20 Universal Outlet, 32A	Call
LMZ-PMP2U24	LIMAZ MonitoredPDU 24 Universal Outlet, 32A	Call
LMZ-PMP2UXXYYNZZ	LIMAZ Monitored PDU XX Universal Outlet, YY C13 Outlet, ZZ C19 Outlet	Call

**UXX** = Q'ty Receptacle Universal Outlets ; 04, 06, 12, 16, 20, 36 Universal Outlet

**YY** = Q'ty Receptacle C13 Outlets ; 04, 06, 12, 16, 20, 36 C13 Outlet

**NZZ** = Q'ty Receptacle C19 Outlets ; 04, 06, 12, 16, 20, 36 C19 Outlet

# Power Distribution Unit

## Switched PDU

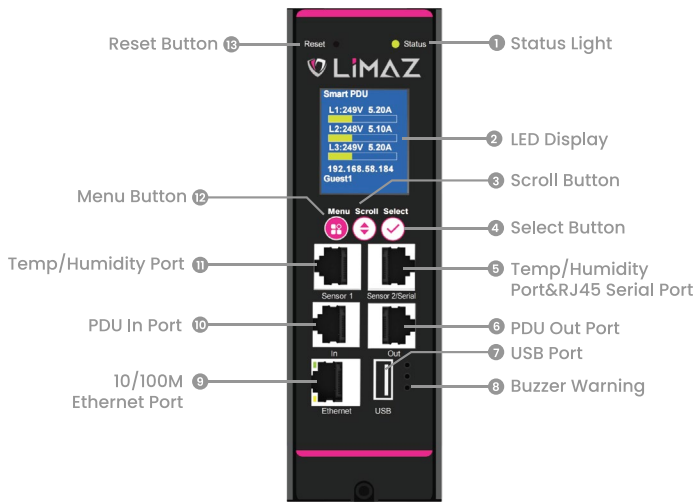

### General Specification

- LCD view the total Voltage, total Power, total Electrical Energy, Power Factor, Load Current of each output unit, ON/OFF/Reboot state of each output unit.
- Optimizes power usage in high-density applications with continuous power monitoring at each PDU
- Delivers proactive environmental warnings and threshold alarms with integrated temperature and humidity monitoring
- Allows the use of a single IP address for connected other PDU
- Various types of sensors : Temperature/Humidity state, Smoke state, Water Logging state, Access Control state
- Multiple Alarms Method : Buzzer beep, Font color to red when view work state, SNMP sent Trap alarm information.

### Ordering Number

Part Number	Description	Price
LMZ-PSP2U12	LIMAZ Switch PDU 12 Universal Outlet, 32A	Call
LMZ-PSP2U16	LIMAZ Switch PDU 16 Universal Outlet, 32A	Call
LMZ-PSP2UXXYYNZZ	LIMAZ Switch PDU XX Universal Outlet, YY C13 Outlet, ZZ C19 Outlet	Call

UXX = Q'ty Receptacle Universal Outlets ; 04, 06, 12, 16 Universal Outlet

YYY = Q'ty Receptacle C13 Outlets ; 04, 06, 12, 16 Outlet

NZZ = Q'ty Receptacle C19 Outlets ; 04, 06, 12, 16 Outlet



LIMAZ



@9cabling



02-678-9199



limazthailand



www.limaz.co.th



admin@ninedistribution.com

